

*AP LCT:*

*Low emission energy technologies*

*(“Tecnologie energetiche a basse emissioni”)*

***Contributo slides INM\_Roma***

***NOTA:***

***dove compare  va inserito un video corrispondente all'immagine che trovate.***

***Vi manderemo I file video separatamente***



# Project Area: Low emission energy technologies

## Renewable energy: wind energy

**Objective:** Offshore & Onshore wind turbines aerodynamic, aeroelastic and aeroacoustic modelling

Prediction of rotor aeroloads under steady and unsteady (wind shear, yaw misalignment, floater motion) conditions.

Integration with floater hydroelastic solvers and control tools for preliminary design purposes.

Noise prediction and analysis of blades elasticity effect on the radiated noise.

### Approach:

Rotor aerodynamics: in-house 2D and 3D aerodynamic solvers

Rotor structural dynamics: Finite Element Method-based (FEM) solver

Rotor aeroacoustics: Acoustic Analogy formulation coupled with suitable CFD aerodynamic solvers.

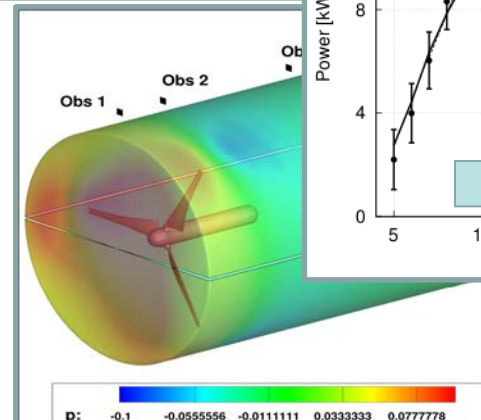
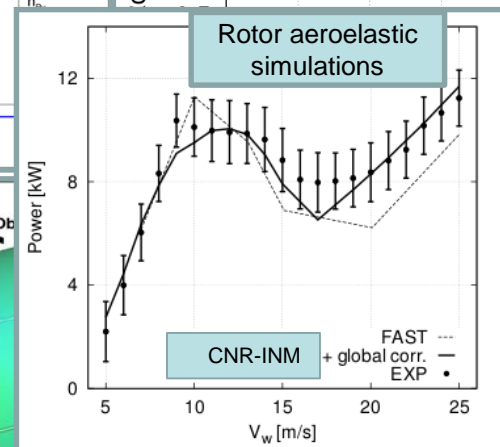
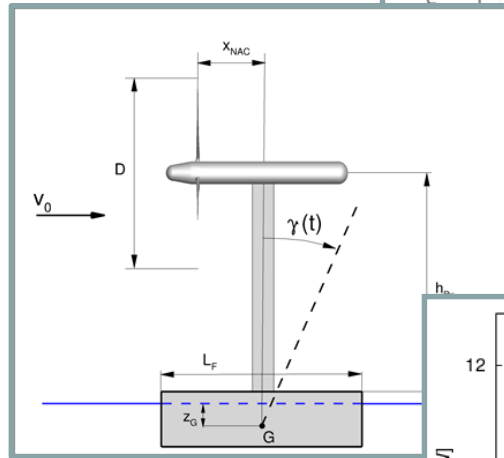
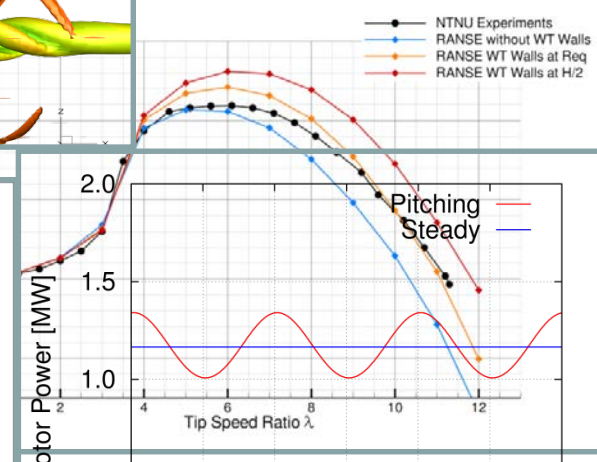
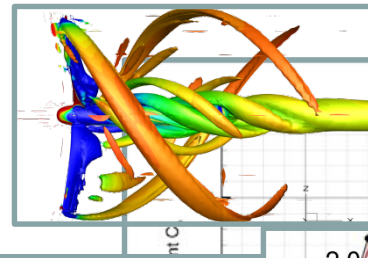

(MPPT)

acking

tion for turbine  
080 1140 1200

### Objectives:

- Enhance comprehension of marine energy conversion physics in real operation at sea
- Underpin technology development through advanced testing and modelling
- Focus on tidal current turbines and OWC systems for onshore wave energy

1 MW Sabella turbine  
deployed in Brittany



1:25 replica  
for lab tests

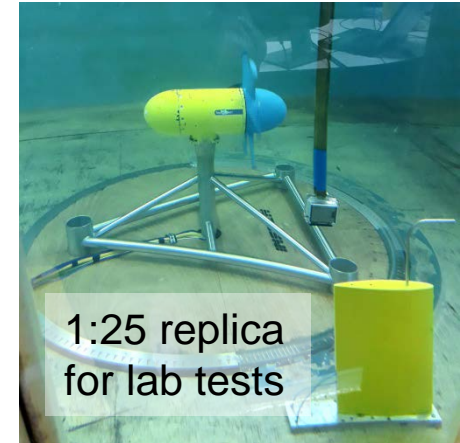

Rotor wake  
by PIV tests

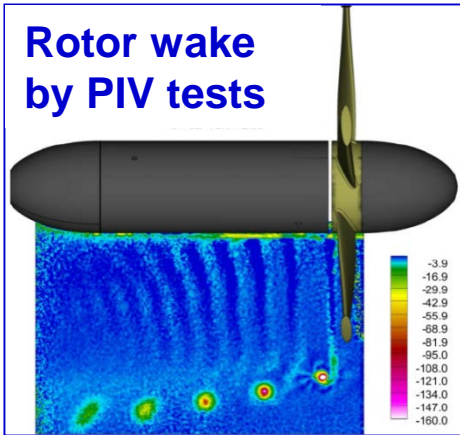

### Approach by INM:

- Enhance experimental technique to simulate sea-relevant conditions by lab tests and compare with full scale
- Develop variable-fidelity computational models for analysis & design of turbines to convert current and wave energy

Rotor wake by CFD

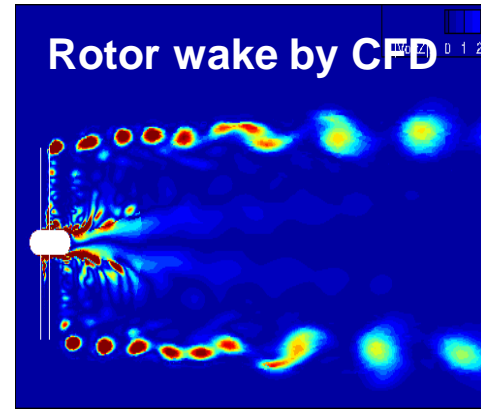

### Scientific impact/results:

- New knowledge by technology transfer from traditional R&D sectors
- Strong internationalization of researchers with EU and global partners
- Research infrastructures part of the EU leading network on ocean energy



**Objectives:**

- Hydrodynamic models of tidal turbines
- Flow characterization of single devices and arrays of rotors in turbulent flow

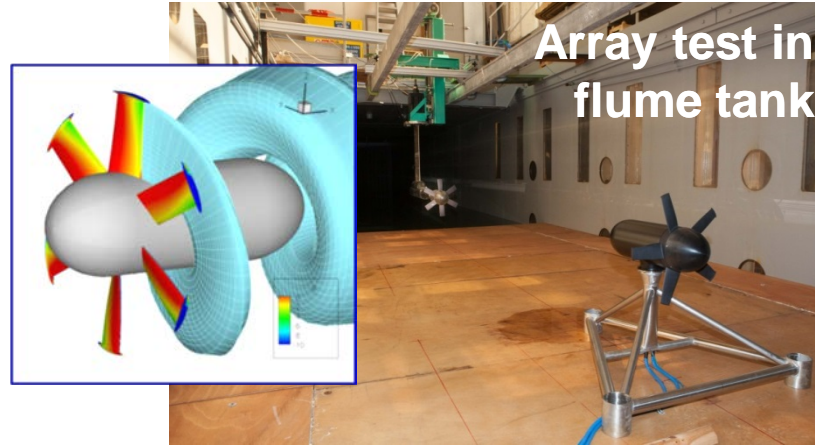

Array test in flume tank

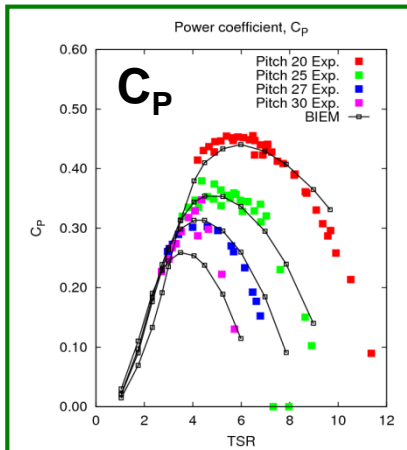
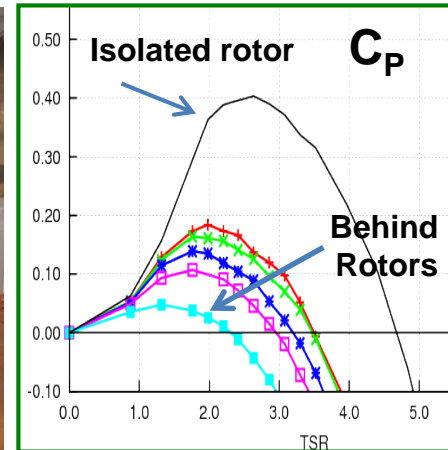

**Approach by INM:**

- Unsteady flow simulations
- Fast models (BEM) for single device power curves
- Hybrid RANS/BEM for turbine wake studies and device/device interactions in arrays

CFD study of interaction between rotors in array

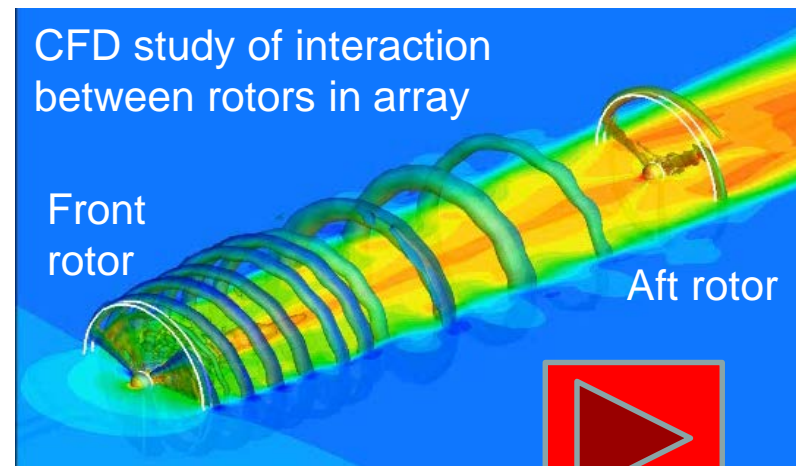

**Scientific impact/results:**

- Analysis of effects of geometrical and operational parameters on single device performance
- Prediction of device/device interaction effects on power produced in arrays





# Project Area: Low emission energy technologies

Renewable energy: Ocean energy / wave energy

## Objectives:

- Study of WECs arrays in design conditions and in extreme seas.
- Wave analysis and forecast in the deployment site.

## Approach by INM:

- Development of analytical and numerical tools for the analysis and optimization of WECs.
- Coupling of different numerical solvers to study local wave action on the WECs and in the region of the deployment site.

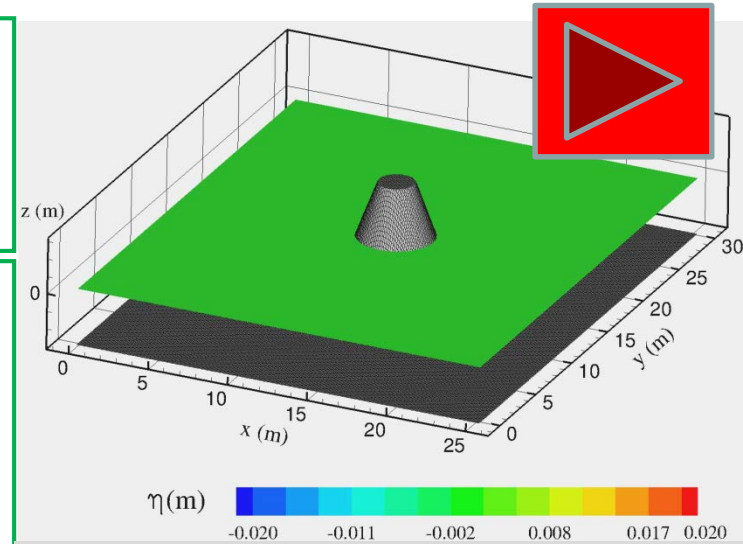

Tsunami wave towards an island

Water flow as a  
function of  
WEC intake

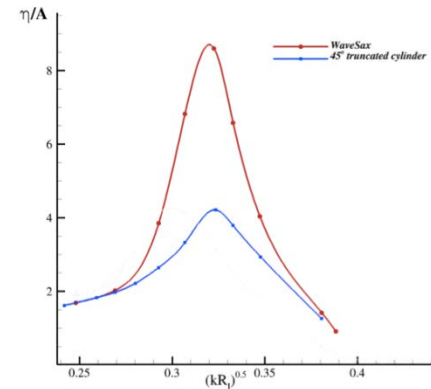
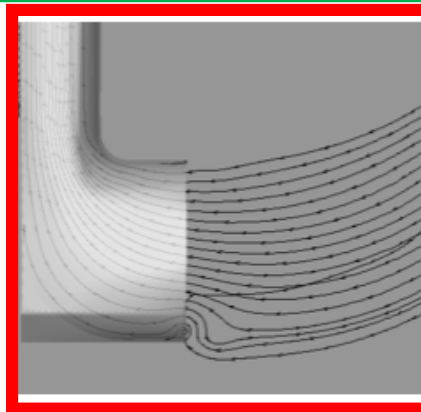
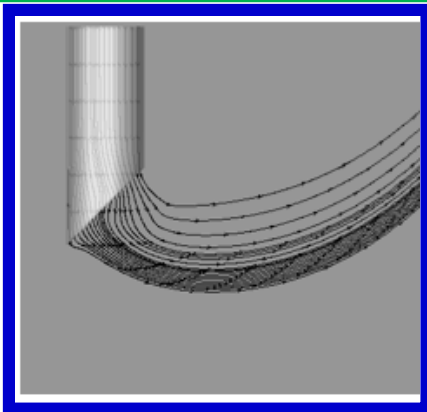

## Scientific impact/results:

- Definition of a range of reliability of the commonly used numerical/analytical solvers
- Wave-to-wire control of WECs



## Objective:

**Theme 1:** Hydrodynamic characterization of elliptic profile models for tidal turbines by means of Temperature Sensitive Paints (Fig. 1).

**Theme 2:** Characterization of the interaction of tidal turbines wake at ground on tidal farm layout optimization by means of Temperature Sensitive Paints (Fig. 2).

## Approach:

The capability of the Temperature Sensitive Paint to capture the laminar-turbulent transition in a boundary layer is connected to the Reynolds analogy that relates the thermal and the mechanical boundary layer growth.

Its application in the study of the elliptic profile blades for tidal turbines allows to shed light on the profile efficiency in a wide range of flow regimes. It can quickly provide information about separation, transition, reattachment and stall conditions.

Its application in the study of the wake-floor interaction inside and around a tidal turbine array can provide a large scale time resolved map of the wake extension and oscillation, providing a clear and immediate picture about the efficiency of the investigated farm layout and about the quality of the incoming flow for each element of the array.

## Figures:

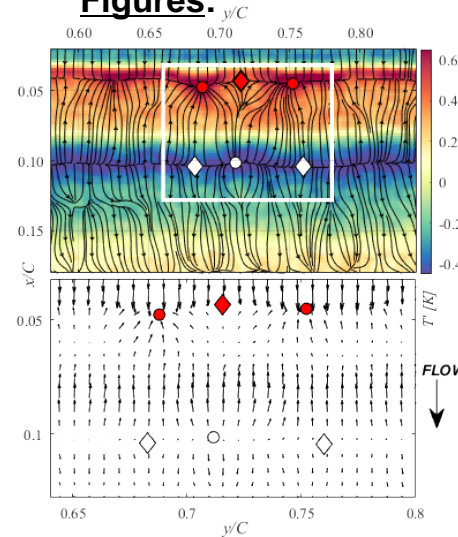

**Fig. 1:** Laminar Separation Bubble temperature, skin-friction topology (top) and vector field for a NACA0015 profile model at  $Re\ 1.8 \times 10^5$

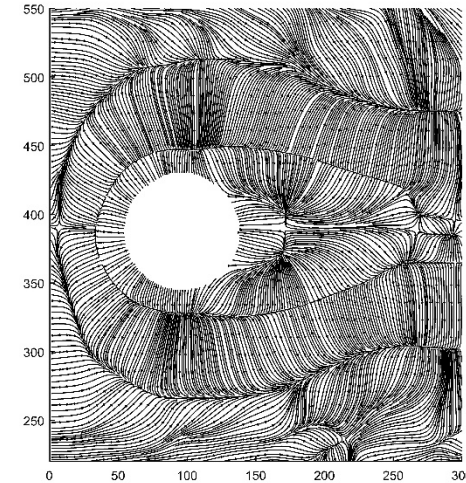

**Fig. 2:** Skin friction topology on the floor after a wall-mounted cylinder. Laminar condition.

## Scientific Impact/Results:

**Theme 1:** The investigation about elliptical profile models is suggested in order to explore how their shape, noteworthy in tidal applications because of its intrinsic bi-directionality, influences the flow separation, transition, reattachment and stall occurrence. This is of particular interest because of the position of the profile's maximum thickness, which make difficult to study their behavior with classical approaches.

**Theme 2:** The interaction of a turbine wake with the floor and with other turbines in a farm is of extreme importance in the turbine farms layout optimization.



# Project Area: Low emission energy technologies

Renewable energy: Wind, Marine Current, PV energy

## Objective:

- Development of distributed generation (DG) systems from renewable sources (RES), wind, marine current, photovoltaic, characterized by:
  - **High dynamic performance;**
  - **High power density;**
  - **Optimal exploitation of the energy source;**
  - **Reduced cost;**
  - **High reliability;**

## Approach:

**High dynamic performance:** new control strategies will be developed, based on both linear and non-control theory, aiming at the achievement of high performance control of the electrical/electromechanical variables of the DG unit

**High power density:** wide band gap (WBG) power devices technologies will be adopted, (SiC and GaN), permitting much higher voltages, frequencies and temperatures than conventional semiconductor materials.

**Optimal exploitation of the energy source:** new maximum power point tracking techniques (MPPTs), of both the P&O (Perturb and Observe) and neural type for PV/wind/marine current generators will be devised and experimentally validated.

**Reduced cost:** specific power converter topologies will be addressed, permitting the adoption of the minimum number of power devices.

**High reliability:** Estimators and observers, based on both linear and non-control theory, will be developed in order to avoid the adoption of expensive sensors (sensorless techniques). The EMI reduction in power converters will be addressed by means of suitable PWM techniques and active/passive filters.

## Figures:



ODEF software for  
PV panels  
characterization



Experimental tests  
In wind tunnel



## Scientific Impact/Results:

- Development of up-to-date technologies with high TRL, related to distributed generation from renewable sources characterized by innovative features
- Technology transfer to SMEs and Industries
- Training of technicians and scientist in the field of distributed generation from renewable sources



# Project Area: Low emission energy technologies

Renewable energy: Solar energy



Consiglio Nazionale delle Ricerche  
Engineering, ICT and Technologies for  
Energy and Transportation Department

## Objective:

The study of indirectly or directly irradiated solar receivers based on compartmented dense gas fluidized beds coupled with thermal and thermochemical storage for CHP generation and/or materials production

## Approach:

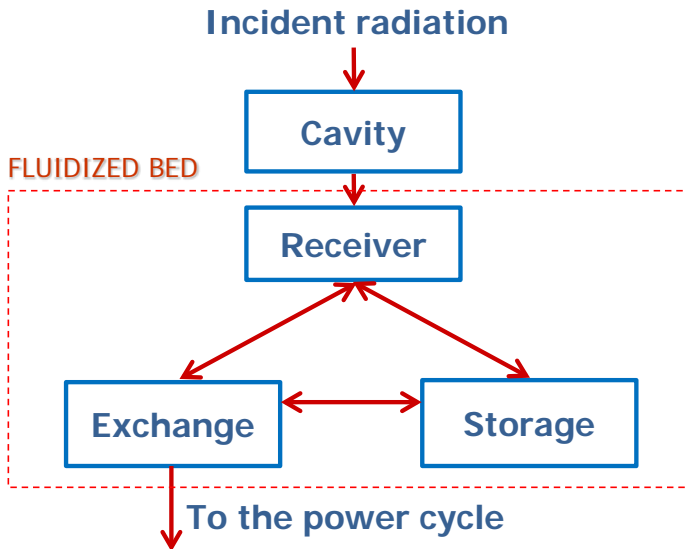

## Figures:

Indirectly irradiated fluidized bed with thermal storage

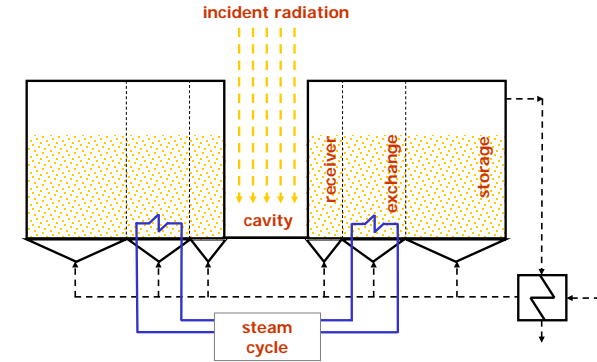

directly irradiated fluidized bed for thermochemical storage and/or material production

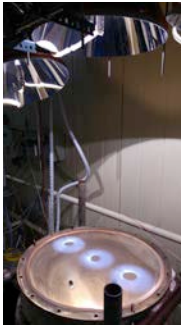

## Scientific Impact/Results:

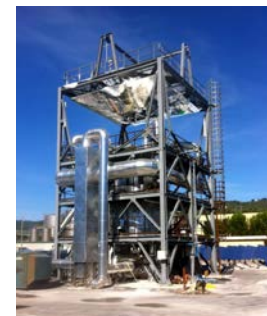

the 125kWth peak load CSP plant at Buccino



the 2MWth peak load CSP plant at San Filippo del Mela





# Project Area: Low emission energy technologies

**Flexibility and sustainability:** Energy storage and carriers



Consiglio Nazionale delle Ricerche  
Engineering, ICT and Technologies for  
Energy and Transportation Department

## Objective:

- Development of innovative and highly performing materials and components for electrochemical storage devices (vanadium redox flow, sodium-ions, iron-air, sodium-nickel chloride batteries and supercapacitors) from battery cell level up to kW battery.
- Improving electrochemical performance in terms of current and power density, round-trip efficiency and cycling.

**The goal is a total costs reduction of the specific technology to allow the up-scaling favouring the market introduction**

## Approach:

- Low cost synthesis methods suitable for scale-up materials:

- Electrospinning technique
- Sol-gel
- Hydrothermal

- Low cost materials and components

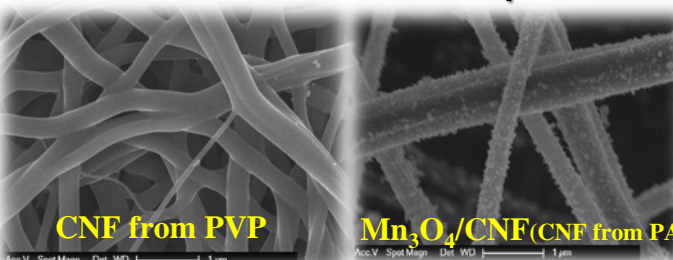

Electrospinning device

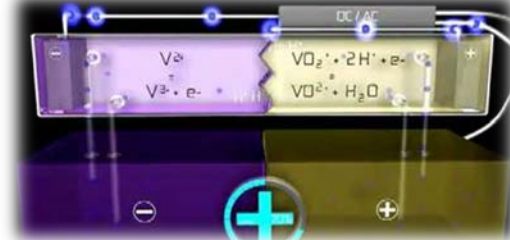

**Vanadium Redox Flow Battery**

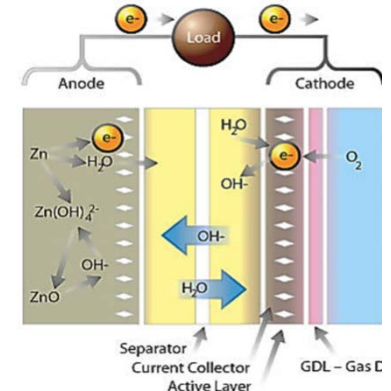
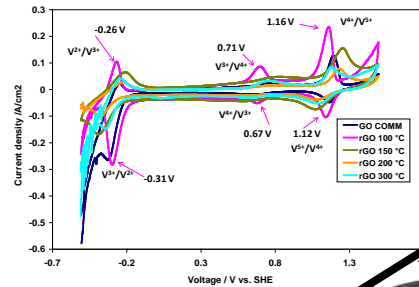

**Iron-air Battery process**

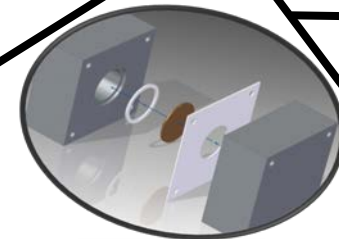
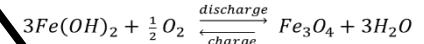
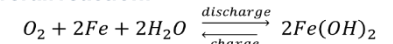

**Na-NiCl<sub>2</sub> innovative planar battery**



**20F - 3V**

**Supercap proof-of-concept**

## Scientific Impact/Results:

- Optimization of materials, components and design with respect to the state of art for current storage technologies
- Proof-of-concept of new electrochemical storage technology



# Project Area: Low emission energy technologies

**Flexibility and sustainability:** Energy storage and carriers



Consiglio Nazionale delle Ricerche  
Engineering, ICT and Technologies for  
Energy and Transportation Department

Energy storage of renewable energy is achieved producing H<sub>2</sub> for fuel cells by water electrolysis, photo-electrolysis, CO<sub>2</sub>-H<sub>2</sub>O co-electrolysis (to store electrical energy in chemicals such as methanol)

## Objective:

- Development of innovative and highly performing materials and components
- Improving the efficiency of the devices.



**1 kW PEM electrolyser system**

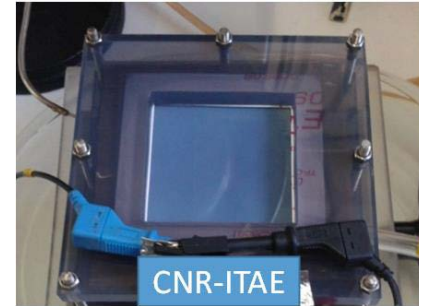

**Photo-electrolysis cell**

## CO<sub>2</sub>-H<sub>2</sub>O co-electrolysis materials and components

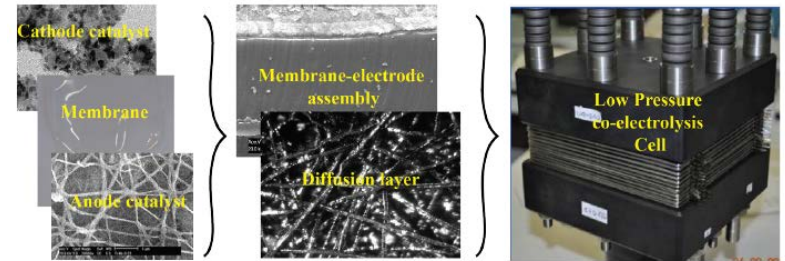

## Scientific Impact/Results:

- Optimization of materials and components
- Development of prototypes to validate the technology and the developed materials.
- Technology transfer and training

System design, system optimization, prototyping and validation in a field test at Emden (Germany)

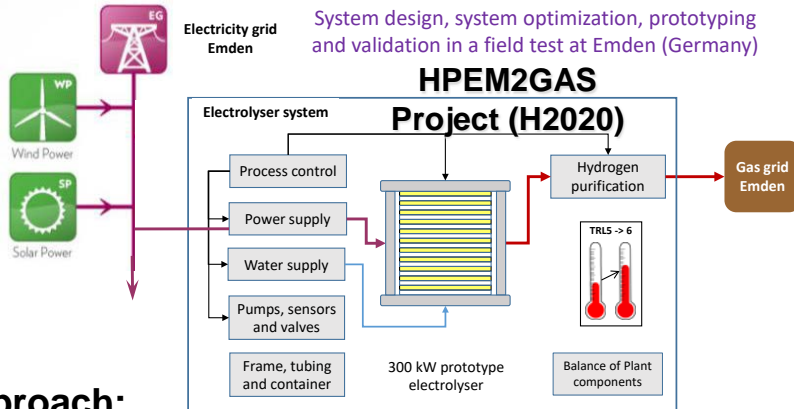

## Approach:

- **Synthesis methods for catalysts suitable for scaling-up**
- **Cost-effective materials and components**

- High Performance PEM Electrolyzer for Cost-effective Grid Balancing Applications (HPEM2GAS): G.A. n° 700008
- Next Generation PEM Electrolyzer under New Extremes (Neptune): G.A. n° 779540
- CRM-free Low Temperature Electrochemical Reduction of CO<sub>2</sub> to Methanol (LOTTER.CO2M): G.A. n° 761093
- Innovative Photoelectrochemical Cells for Solar Hydrogen Production (FotoH2): G.A. n° 760930



# Project Area: Low emission energy technologies

## Flexibility and sustainability: Fuel cells

**Objective:** The EU targets are the reduction of greenhouse gas (GHG) emissions by 40% by 2030 and by 80-95% by 2050 compared with 1990. Polymeric Electrolyte Membrane Fuel Cells (PEMFC) are environmental friendly. Although substantial progress has been achieved in the development of membrane-electrode assemblies (MEAs) for fuel cells, their high cost hinders the commercial breakthrough of PEMFC. Therefore it is urgently to improve MEA performance and durability to reduce cost and enable marketability of FC.

**Approach:** The development of new materials and improved membrane electrode assemblies is required to enable cost, performance and lifetime targets to be attained. It is necessary to develop and modify materials, such as polymeric membranes, ionomer dispersions, catalysts (e.g. Pt alloys and new supports with higher stability), and integrate them into high performing MEAs with superior durability. At the same time, it is necessary to improve the design of the stack. The problem related to the sealing concepts and stack design, such as the edge protection of the membrane and the sealing concept for the cooling media, have to be depth investigated to enhance the lifetime of the system.

### Figures:

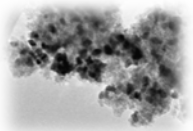

Catalysts based on Pt



Polymer functionalisation



Membranes

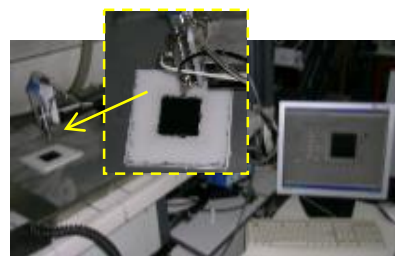

Automatic spray technique

Onto carbonaceous support

on Teflon and decal onto membrane

Onto membrane



MEA



3.5kW - M T PEM  
2 x 1.5 kW modules

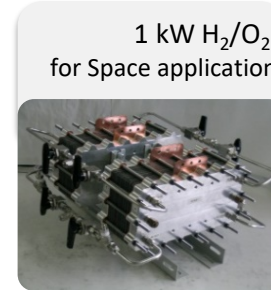

1 kW H<sub>2</sub>/O<sub>2</sub>  
for Space application



5 kW H<sub>2</sub>/air  
for Marine application

**Scientific Impact/Results:** The development of components such as catalysts, polymeric membranes, electrodes and MEAs, and their scale up from the lab scale to bigger size, has permitted the realisation of prototypes in a wide range of electric power. In particular a 3.5kW stack operating at 120°C for automotive, a 1kW stack operating in H<sub>2</sub>/O<sub>2</sub> for space application and a 5kW stack operating in H<sub>2</sub>/air for marine APU applications were developed.





# Project Area: Low emission energy technologies

## Flexibility and sustainability: Fuel cells

### Objective:

- Solid Oxide Fuel Cells (SOFCs) are based on *ceramic materials* and operate at high temperatures between 800-1000°C.
- The challenges in this sector are regarding the *reduction of the operation temperature* and the direct utilization of hydrocarbons.
- This will allow to decrease degradation and make the device cost-effective by system simplification (reduced fuel processing) and use of cheap ferritic steel interconnectors.

### Approach:

- The approach is to develop ceramic electrolytes for intermediate temperature operation based on ceria and gallates, use a multifunctional electrocatalytic layer at the anode to favour internal fuel processing and tailor the composition of the perovskite cathodes to speed-up the oxygen reduction process

### Figures:

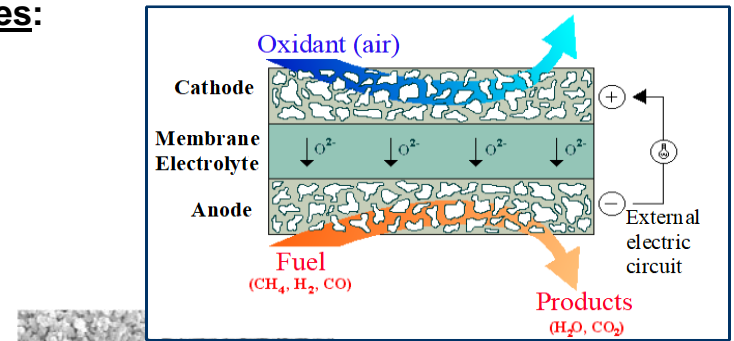

### Scientific Impact/Results:

- The new materials and cell architectures have been validated for the direct oxidation of hydrocarbons such as methane, ethanol, bio-gas, propane, reformed diesel etc. in systems up to 2 kW power





# Project Area: Low emission energy technologies

**Flexibility and sustainability:** Power grids

## Objective:

Design and experimental prototyping of several typologies and topologies of electronic power converters with high dynamic performance and high efficiency for interfacing the smart micro-grid with the main power network, renewables sources based generators and storage systems (batteries, supercapacitors).

## Approach:

Wide band gap (WBG) power devices technologies will be adopted, (SiC and GaN), permitting much higher voltages, frequencies and temperatures than conventional semiconductor materials.

The following typologies of power converters will be focused:

- DC-AC voltage source inverter (VSI), both in traditional 2-level and in multilevel configurations (particularly NPC = Neutral Point Clamped), including the related pulsewidth modulation techniques (PWM);
- AC-AC based on the combination of DC-AC converters in back-to-back configuration.
- DC-DC converters: buck, boost, bi-directional type. In particular boost converters with innovative structures characterized by high efficiency and low cost (low number of power devices) for the connection of fuel cell (FCS), micro-wind, marine and photovoltaic systems will be devised.

Innovative PWM and control techniques will be implemented experimentally on embedded platforms (DSP, FPGA, micro-controllers).

## Figures:



3-level NPC  
Voltage Source Inverter  
(20 kW)



DC-DC bidirectional  
Converter (2.6 kW)

## Scientific Impact/Results:

- Development of innovative power converters and related PWM and control techniques
- Technology transfer to SMEs and Industries
- Training of technicians and scientist in the field power converter design and control.



# Project Area: Low emission energy technologies

## Flexibility and sustainability of energy and power:

### Smart Micro-grids

#### Objective:

- Definition of new architectures for the electric energy distribution in smart micro-grids: DC distribution systems and hybrid AC/DC, with one or more voltage levels and their adoption in residential/commercial buildings as well as in smart vehicles, including ships.
- Definition of methodologies for the optimal and coordinated management, in smart micro-grids, of the following actors:
  - Distributed generators from renewable sources;
  - Stationary generation units (Fuel-cells);
  - Storage systems.
  - Loads.

#### Approach:

Development of data reconstruction and forecasting techniques of electric/meteo-climatic data as a part of the intelligent management of electric power grids:

- 1) electric energy production from renewable sources;
- 2) load demand.

Definition of EMS algorithms pursuing one or several specific goals:

- 1) maximum efficiency;
- 2) minimum losses;
- 3) minimum operating cost;
- 4) maximum self-sufficiency in islanded operation;
- 5) minimum uncertainty of the grid exchanged power profile.

Implementation of the forecasting and management algorithms on embedded platforms (FPGA, micro-controllers).

#### Figures:

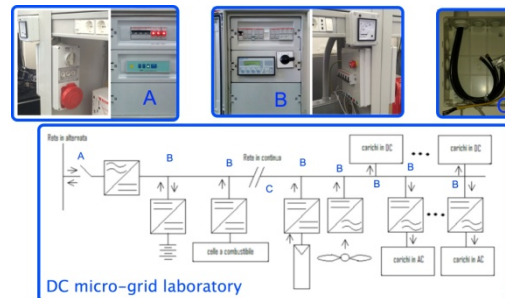

Flussi di potenza governati da EMS

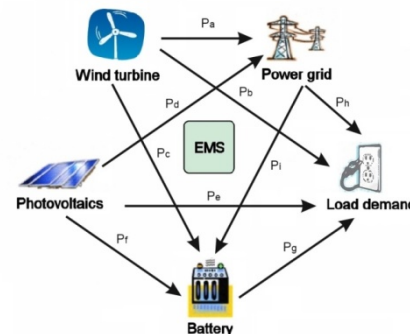

#### Scientific Impact/Results:

- Development of innovative distribution architectures of smart micro-grids and related energy management systems, of potential interest from the power network manager and companies.
- Technology transfer to SMEs and Industries
- Training of technicians and scientist in the field smart micro-grids and their management



# Project Area: Low emission energy technologies

## Flexibility and sustainability of energy and power:

### Integrated systems/mCHP

#### Objective:

Fluidized bed CSP is integrated with thermochemical conversion of biomass to obtain a micro-CHP generator very flexible on the renewable source.

#### Approach:

Fluidized bed combustion for clean conversion of different biomass  
Heater of the Stirling engine immersed in the fluidized bed to exploit extremely high heat transfer coefficients and avoid fouling issues.  
Scheffler fixed focus concentrator to reduce weight and cost.

#### Figures:

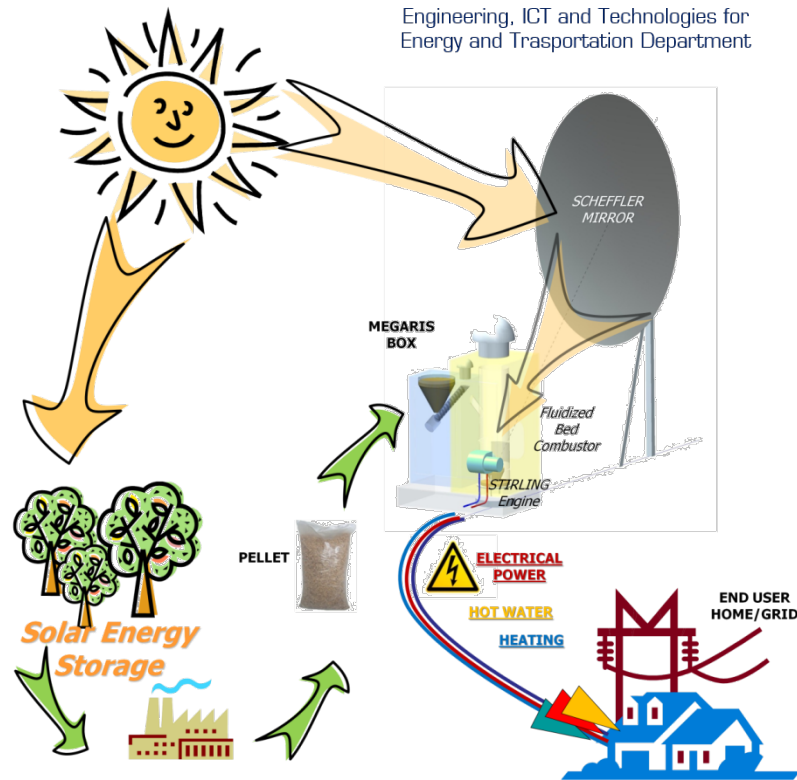

#### Scientific Impact/Results:

This new system introduces several innovative solutions for micro-CHP enabling the possibility to produce heat and power 24h/day in off-grid sites practically at the sole cost of the system installation adopting locally harvested energy sources and without additional storage systems.



# Project Area: Low emission energy technologies

## Flexibility and sustainability of energy and power:

### Energy storage and carriers

#### Objective:

Chemical storage of solar energy as fuels through two-step thermochemical  $H_2O/CO_2$  splitting cycles.  $H_2/CO$  mixture can be used as fuel itself or as feed for gaseous and liquid fuels production.

#### Approach:

- Developing novel bi-functional ceria- and perovskite-based materials showing improved splitting features.
- Developing novel reactor configurations based on fluidized bed solar receivers considering both internally circulating and interconnected fluidized bed options

#### Scientific Impact/Results:

- Doped ceria and bi-functional perovskites successfully prepared and tested in  $H_2O/CO_2$ -STS
- Tunable redox properties of materials by tuning their chemical composition
- materials and solar receivers optimization to increase the solar-to-chemical efficiency up to levels feasible for industrial applications improving reactor solar capture efficiency and enhancing the self-reduction and splitting properties of the materials

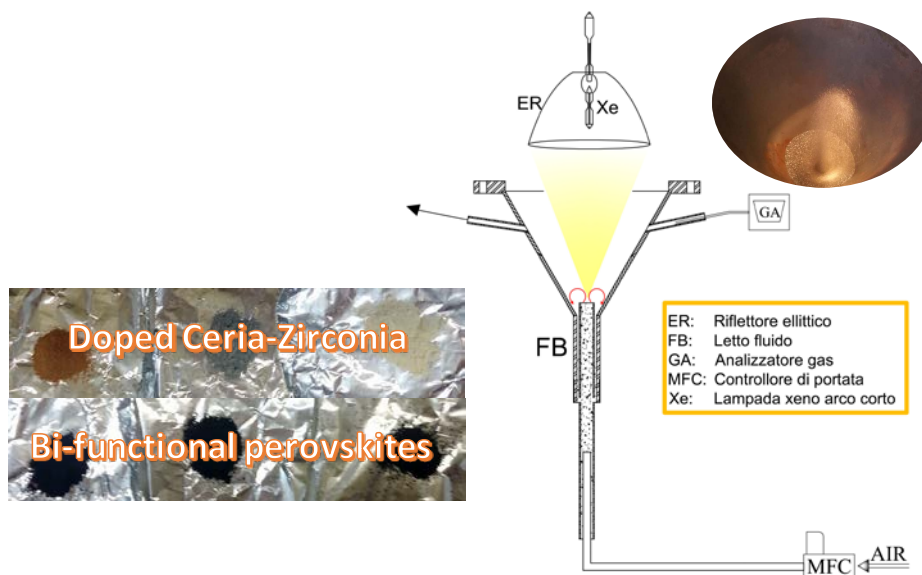
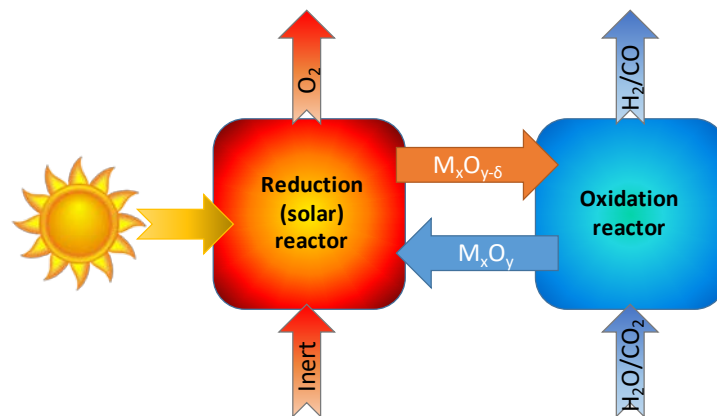





# Project Area: Low emission energy technologies

## Flexibility and sustainability: Emission control



Consiglio Nazionale delle Ricerche  
Engineering, ICT and Technologies for  
Energy and Transportation Department

### Objective:

•Change in fuel composition or energy mix influence the design of the conversion system but also pollutants. It is urgent to improve knowledge on Formation mechanisms of new pollutants, and develop new diagnostics and abatement methodology.

### Approach:

Research activities are focused on:

1. Formation mechanisms of pollutants;
2. Advanced diagnostics for regulated / unregulated pollutants;
3. Reduction of pollutants from fossil and alternative fuels.

Specific activities include in-situ, on-line and off line advanced diagnostics of pollutants and ultrafine particles; diagnostic of flame instabilities; NO<sub>x</sub>, SO<sub>x</sub> and particulate reduction; SCR; Combined particulate and NO<sub>x</sub> reduction; NO<sub>x</sub> storage-decomposition for automotive application; PM reduction through water vapor condensation; Hg capture from flue gases; purification of CO<sub>2</sub> streams; tar and VOC abatement.

### Figures:

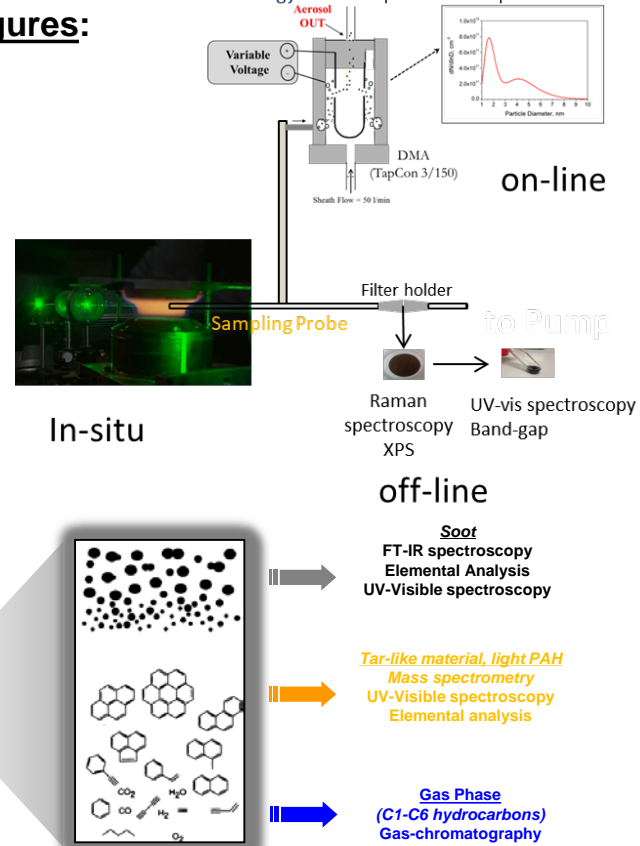
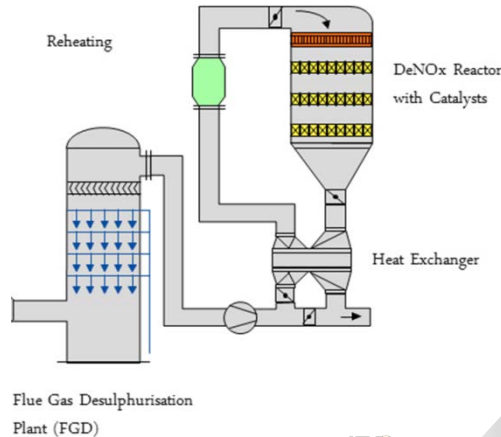

### Scientific Impact/Results:

- Physicochemical characterization of combustion generated carbon nanoparticles
- Characterization of main combustion products and intermediates
- Intensification of catalytic processes and development of novel materials



# Project Area: Low emission energy technologies

## Flexibility and sustainability: Efficiency of fossil fuels plants

### Objective

To sustain technological development of thermal power plants in the scenario of intermittent operation and diversification of fuels

### Approach:

- Flames diagnostics
- Atomization and sprays
- Turbulent flow mixing
- Fluid-dynamics of multiphase reactors
- Single particles reaction modeling
- Reaction kinetics under steady and dynamic operation
- Dynamics of granular systems
- Dynamics of fluidized bed reactors
- Dinamics of non linear processess

### Figures:

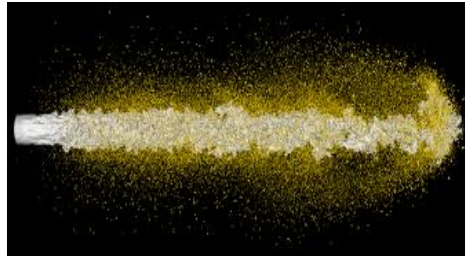
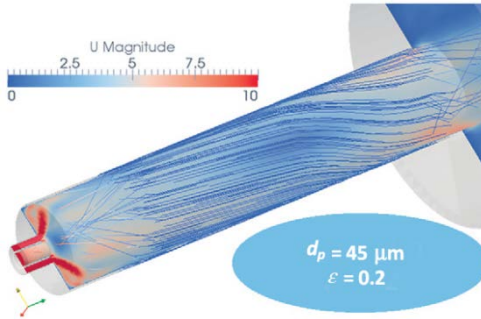
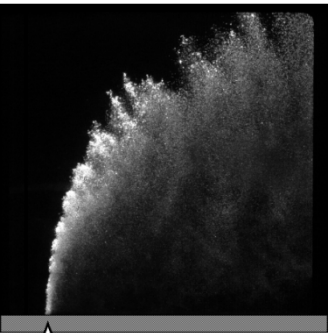
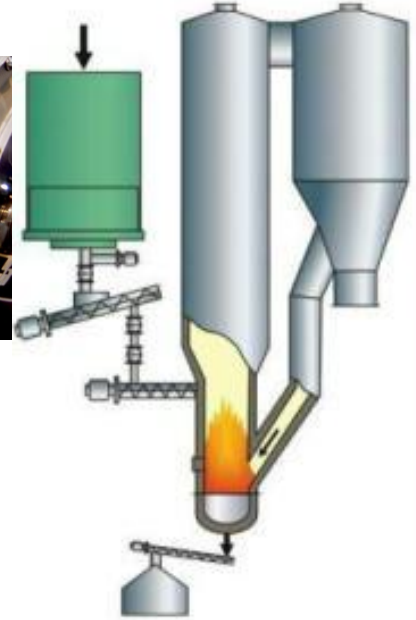
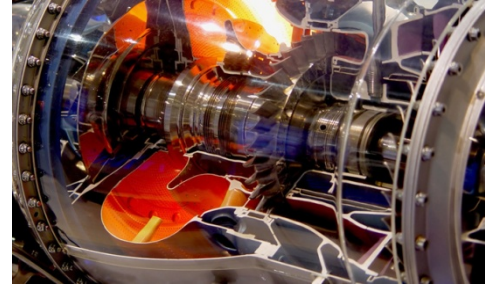

### Scientific Impact/Results:

- Fundamentals of combustion
- Fundamentals of reactor design
- Detailed kinetics
- Fragmentation/annealing/Particles-wall interaction
- Optimization of reactor design
- Increase of efficiency, minimization of environmental impact



# Project Area: Low emission energy technologies

**Flexibility and sustainability: Operational and fuel flexibility**



Consiglio Nazionale delle Ricerche  
Engineering, ICT and Technologies for  
Energy and Transportation Department

## Objective:

Development of innovative combustion technologies to meet the need of:

-Operational **flexibility and efficiency** in a wide minimum/maximum and variable load range (minimum load, hot/cold start, ramp rate)

-**Fuel flexibility** for the **exploitation of** energy carriers derived from locally available resource and from **chemical energy storage**

For supporting the low carbon economy and the exploitation of variable renewable energy resource

## Approach:

Identification of

- new paradigms: **MILD Combustion** (flameless, noiseless, no or extremely low pollutant emission)
- Innovative “scale bridging” configurations

Exploration of :

- wide ranges of operational parameters (power, temperature, pressure, dilution, oxygen concentration)
- standard and **new energy carriers** (carbon based and no carbon fuels, like **Hydrogen** and **Ammonia**)



**NH<sub>3</sub>**

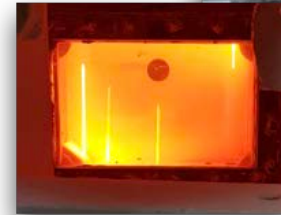

Laboratory Unit CYclonic burner

**CH<sub>4</sub>**

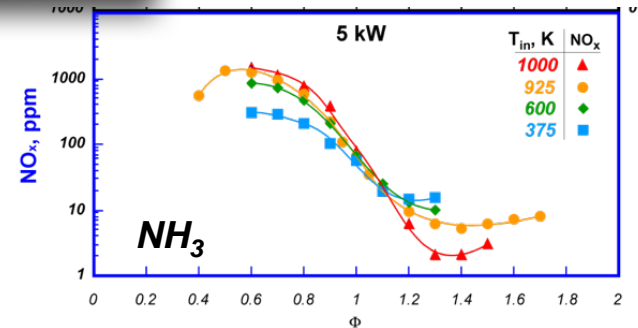

## Scientific Impact/Results:

- MILD Cyclonic burner technology validated in lab (TRL4-5)
- Optimization of tools for modeling and design of innovative combustion processes (kinetic models, advanced reactive turbulent system modeling, turbulence-chemistry interaction models)
- Characterization of Elementary reactive structures in MILD/flameless conditions



### Objective:

Development of Processes and Technologies for material recovery and for the energetic valorization of wastes and biomasses

### Technologies:

- Fluidized beds
- Entrained flow reactor
- Fixed beds
- Rotary kilns
- Plug flow reactors

### Approach:

- Detailed fuel and products characterization
- Reactor design
- Catalyst design
- chemical kinetics definition
- transport phenomena effects
- Fluid-dynamics and chemical kinetics optimization
- Feedstock and process evolution interactions

### Scientific Impact/Results:

Valorization of biomass, agro-wastes, wastes from industry, end-of-life consumer goods for the production of gaseous and liquid fuels by thermochemical (torrefaction, pyrolysis, gasification combustion) and biotechnological and biorefinery processes

## Feedstocks



(Olive Husk)



orange peel

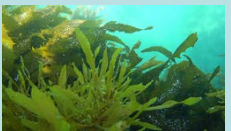

Algae



Tomato peel





**Polymeric Wastes**  
(Tyre or PET Wastes)



pelletized sludge

## Facilities







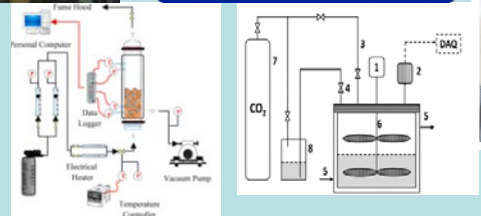

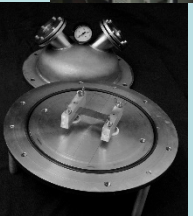

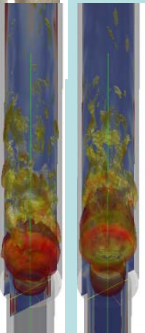



**Steps of development of innovative materials/catalysts**





### Objective:

Upgrading of thermo-chemical processes applied to waste and residual biomass to produce energy carriers (H<sub>2</sub> rich syngas / bio-oil)

### Approach:

- ✓ Improvement of H<sub>2</sub> content in gasification syngas stream working with:
  - fluidized bed reactor (BFB)
  - solid catalysts
  - air-steam as oxidant agent
  - Computational fluid dynamics modelling (CFD)
  
- ✓ Production of “high quality pyrolysis bio-oil” through *in situ* catalytic upgrading - Preparation, characterization and testing of solid supported catalysts



Citrus peel residues



Beached seaweed

**Thermo-catalytic conversion**  
 - Gasification  
 - Pyrolysis



### Scientific Impact/Results:

Citrus peel residues resulted a promising biomass for syngas production due to the lower lignin content than woody material

Citrus peels air-steam gasification (750°C, E/R=0.3; S/B=1 wt/wt) recorded an H<sub>2</sub> yield= 2.55 Nm<sup>3</sup>/kgbiomass; syngas yield=0.69 Nm<sup>3</sup>/Kgbiomass

Bio-oil from Posidonia Oceanica sea-plant was obtained with a yield=52 wt% (T=500°C)

The bio-oil oxygen content was reduced from 30 wt.% to 6.8 wt.% through *in situ* upgrading with CeO<sub>2</sub> catalyst than no-catalysts pyrolysis run



# Project Area: Low emission energy technologies

## Bio and alternative fuels: H<sub>2</sub>/syngas from biogas

### Objective:

Design, realization and tests of compact reactors and small-scale demonstrative units for the conversion of the biogas into a hydrogen-rich mixture by different reforming processes, finalized to hydrogen or syngas production and/or integration with Fuel Cell systems for mobile and stationary applications in the range of 2kW.

### Approach:

Design finalised to:

- develop a compact unit, integrable with different downstream processes;
- process different biogas feedstocks with high efficiency;
- use of low-cost Ni-based catalysts.

### Scientific Impact/Results:

- Conversion of biogas into a bio-syngas rich in H<sub>2</sub> and CO with high efficiency 75-80%(LHV);
- Optimal thermal integration with SOFC for CHP application;
- Stable performance toward real biogas (CH<sub>4</sub>=60%, CO<sub>2</sub>=40%, flow = 10 NI/min) feed from industrial Waste Water Treatment Plant (around 6 months of operation, SOFCOM EU project);
- Possibility of adjusting the H<sub>2</sub>/CO molar ratio for other application such as Fischer–Tropsch or Oxo-synthesis processes;

### Reformer features

- Hydrogen Production (in syngas) : Nominal = 2 Nm<sup>3</sup>h<sup>-1</sup>, Maximum = 3 Nm<sup>3</sup>h<sup>-1</sup>
- Size: Length = 80cm, Height = 100cm, Width = 100cm
- Process : SR reforming /oxy-steam reforming



*View of the Reformer connected with SOFC (SOFCOM EU Project )*



### Objective:

Combustion properties and kinetics of gen II and III biofuels

### Approach:

The chemical composition of Bio and Alternative fuels is extremely complex, leading to huge chemical detailed mechanism.

To study their property, propose surrogate fuel compositions, assess their reliability in practical combustion device, numerical tools needs to be developed:

- Integration of stiff ODE
- Parametric continuation of large system of equations and detection of bifurcation points
- Automatic reduction of detailed kinetic schemes

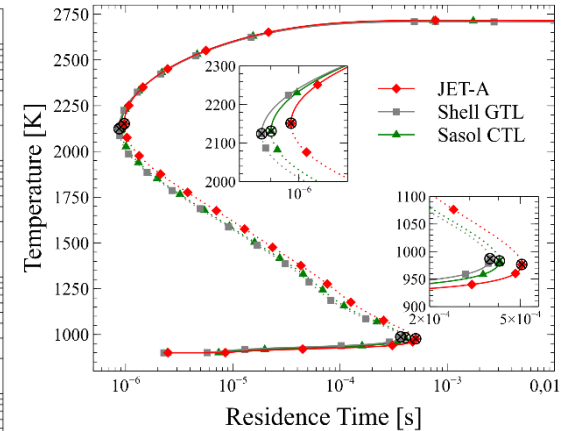
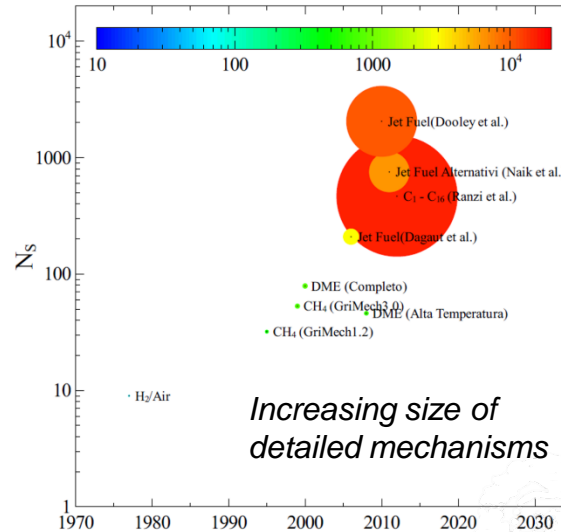

*Parametric continuation of three different Jet fuels with detailed mechanisms*

### Scientific Impact/Results:

A numerical library developed and continuously updated

A new approach for automatic reduction of detailed mechanisms based on entropy functions developed and assessed

New algorithms to perform parametric continuation using detailed mechanisms to accurately reproduce the behavior of bio and alternative fuels

New test functions for detection of bifurcation points proposed



# Project Area: Low emission energy technologies

## Bio and alternative fuels

### Objective:

Thermochemical conversion of solid fuels:

- in different atmospheres
- up to 2200°C
- up to 20 bar
- Heating rate up to 10000 K/s
- Bulk or single particles conditions

### Approach:

Fuel's physical and chemical transformation are studied under a wide range of conditions:

Pyrolysis/combustion/gasification kinetics

Swelling, fragmentation

Annealing and microstructure

Volatiles and soot r

### Scientific Impact/Results

Fundamentals of biomass transformation

Kinetics and process design

Optimization of thermochemical processes of biomass and wastes

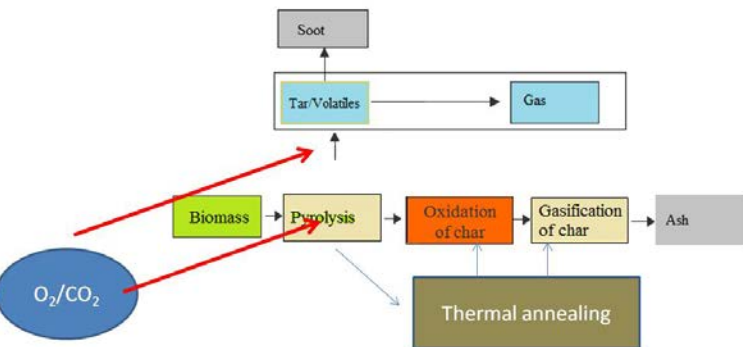

### Facilities

Reactor type	TGA	FixBR	FBR	DTR	WMR/HSR	ALPR
Process type	Batch	Batch	Batch	Continuous	Batch	Batch
Temperature	<900°C	<900°C	850°C	1300°C	1500-2000°C	700-1000°C
Particle size	0.1 mm	0.1-1 mm	1-10mm	0.1 mm	0.1-1 mm	0.1-1 mm
Sample mass	10 mg	1 g	1-10 g	-	0.1-1 g	0.1-1 g
Heating rate	1-50 °C/min	5 °C/min	10 <sup>3</sup> °C/s <sup>+</sup>	10 <sup>4</sup> C/s	10 <sup>5</sup> °C/s	10 <sup>3</sup> -104 °C/s
Residence time (s)	Min-hours	Min-hours	min	<1s	0.1-10 s	min
Gas analysis	yes	yes	yes	yes	ni	yes
Tar analysis		yes		yes	ni	
Solid analysis		yes	yes	yes	yes	

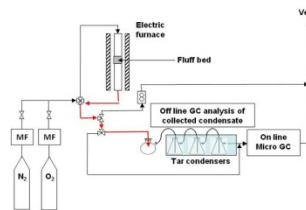

TG-MS Stirrer

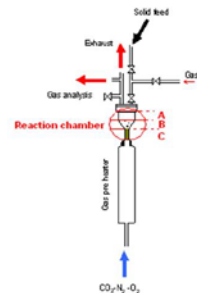
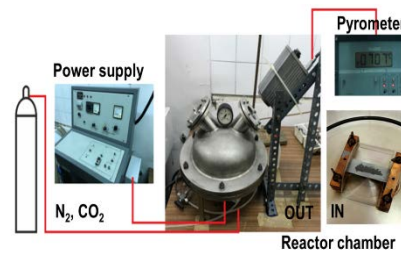
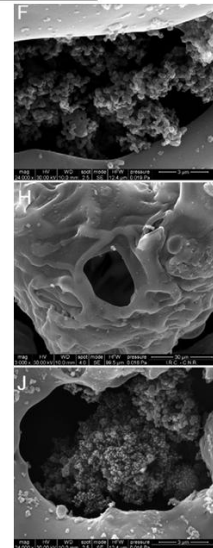
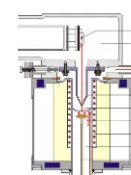

### Tar Analysis

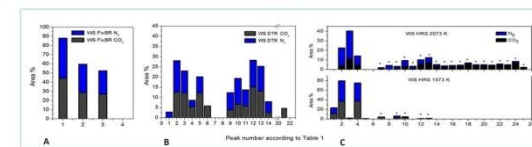

Area% of peaks of species detected by GC-MS (see Table 1 (PAH compounds are marked with \*)):  
A) FixBR at 873 K, B) DTR 270 mm, C) HRS in N<sub>2</sub> and CO<sub>2</sub> environment.







# Project Area: Low emission energy technologies

## Bio and alternative fuels

### Objective:

Characterization of the burning properties of **biogas** and **syngas**, in conditions typical of heat engines & burners

### Approach:

Study of the core process in precision-controlled conditions:

- Constant-volume reactor ( $P_{\max} > 200$  bar)
- Working range:
  - base pressure ( $\leq 30$  bar)
  - air/fuel ratio (spanning the flammability range)
  - mixture composition ( $\text{CH}_4$   $\text{H}_2$   $\text{CO}$   $\text{CO}_2$   $\text{N}_2$ )
- High time & space resolution diagnostics

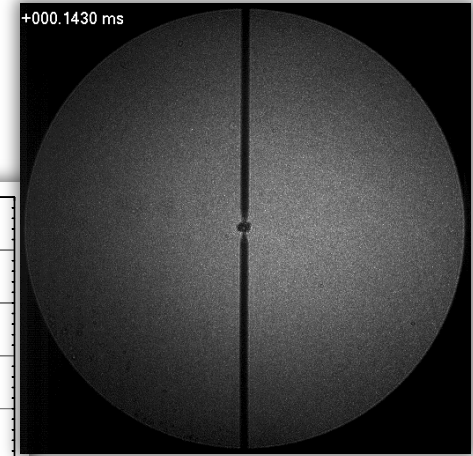
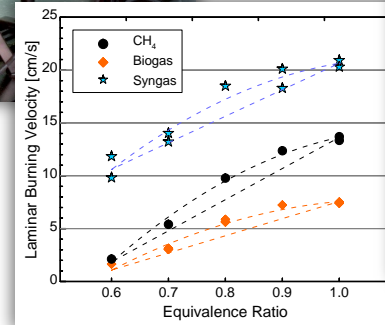
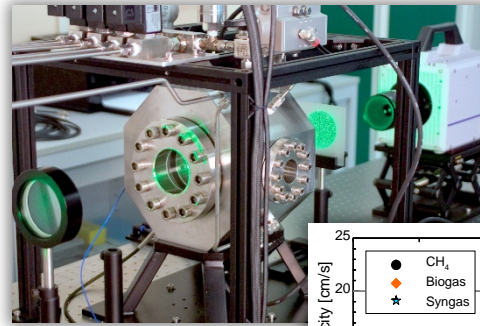

syngas flame at  $P_0=10$ bar

### Scientific Impact/Results:

To suggest guidelines (design specifications and operating strategies) for the development of high-efficiency, ultra low-emission energy conversion systems, based on:

- biomass & waste derived fuels (biogas, syngas)
- $\text{H}_2$  enhanced fuels

Twofold development path:

- **direct**, through the compared analysis of combustion tests and real systems operation
- **indirect**, using the test results to implement/validate kinetic models and to improve multidimensional codes.



### Objective:

- Efficient use and low emissions of bio fuels for applications in practical systems.
- Development of high efficiency and low emission combustors.

### Approach:

The optimization of a fuel passes through the knowledge and the analysis of the combustion characteristics exhibited by the fuel in the conditions in which it must be used (in particular ambient temperature and pressure).

The main characteristics of a fuel droplet to be determined are the ignition delay, evaporation/combustion rate, temperature evolution, swelling, micro-explosion, flame thickness and distance from the surface of the droplet, formation of submicronic (soot) and macroscopic (cenosphere) carbonaceous particulate.

### Scientific Impact/Results:

- Optimization of bio-fuels production processes
- Characterization of II and III gen bio fuels (pyrolysis oil, algal biomass, etc.)
- Bio fuels from waste and biomass of low commercial value
- High quality bio fuels (e.g., aeronautical applications)

Layout of the single droplet combustion chamber to investigate the combustion properties of biofuels

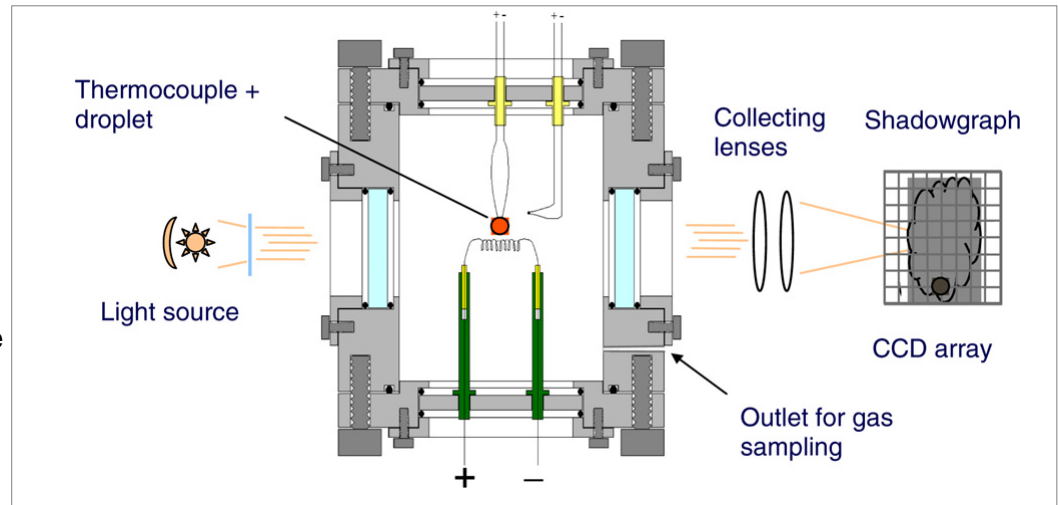

Main characteristics: synchronized acquisition chain (thermocouple data and images), test in controlled conditions (pressure and temperature). pressure up to 10MPa.

Some images from test of crude pyrolysis oil droplet ( European project: R2H - Renewable residential heating with fast pyrolysis bio - oil)



Start of test

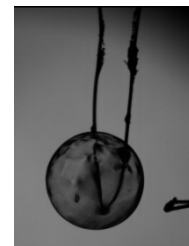

Droplet swelling

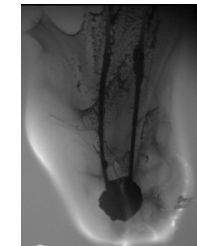

Soot formation

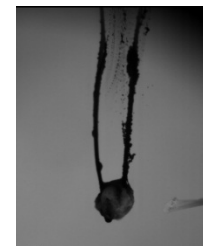

Cenosphere



# Project Area: Low emission energy technologies

## Bio and alternative fuels

### High energy ignition system – optical characterization DI SI engine fueled with bio-butanol

#### Objective:

Characterization of a plasma-assisted ignition system for bio-butanol fueling

#### Approach:

Combined thermodynamic and optical techniques were applied on a light duty spark ignition engine for characterizing the performance of a high energy ignition system during butanol fueling. Plasma properties were analyzed based on visualization data for arc dimension and location, as well as chemical species through spectroscopy. Post-processing of the optical data allowed the comparison of flame front characteristics with cyclic variability determined based on recorded in-cylinder pressure. Optimization of ignition settings with respect to fuel properties was based on correlating measured engine output parameters with flame propagation. Integration with variables monitored by the control unit provided by the industry partner was continuously achieved throughout the project.

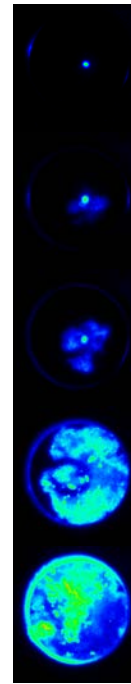

optical  
accessibility

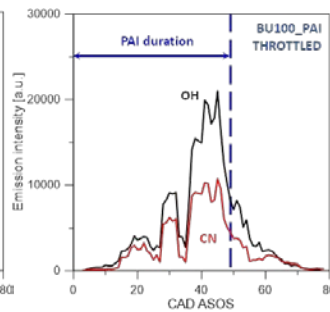
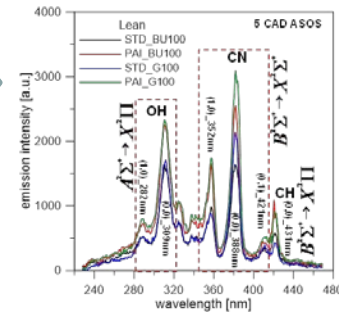
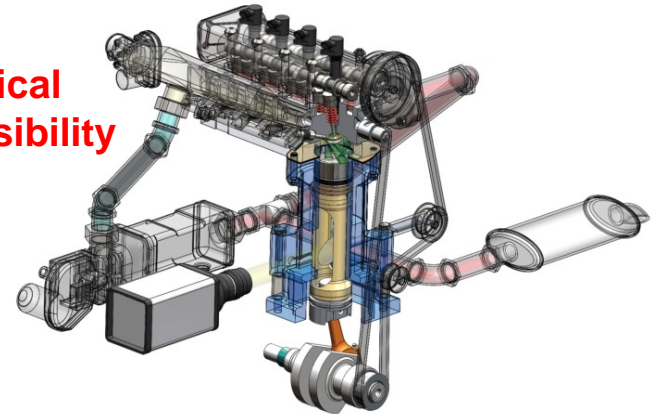

#### Scientific Impact/Results:

Improved stability was obtained by applying plasma-assisted ignition, especially during lean operation, which proved problematic for bio-butanol and other bio-alcohol fuels with respect to gasoline..



# Project Area: Low emission energy technologies

## Bio and alternative fuels

### *Syngas fueling – optically accessible spark ignition engine*

#### Objective:

Identification of hydrogen concentration effects on syngas combustion in spark ignition engines

#### Approach:

In-cylinder pressure measurements, exhaust gas emissions data and flame visualization were combined for a comprehensive characterization of combustion in an optically accessible SI engine fueled with syngas. Different compositions were investigated, with an emphasis on the combustible components ( $\text{CO}$ ,  $\text{H}_2$ ,  $\text{CH}_4$ ), as well as the effects of inert gases, such as  $\text{N}_2$  and  $\text{CO}_2$ . Detailed post-processing of imaging data was aimed at identifying the concentration of hydrogen as a significant factor of influence on flame front characteristics. Numerical investigations were used as a complementary technique and offered the potential of opening a new line of research to further enhance the international collaboration with several partners.

experimental  
data ITA, Brazil



in-depth analysis and post-  
processing IM-CNR, Italy

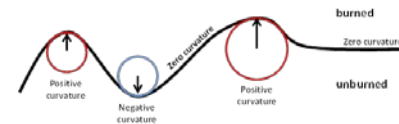
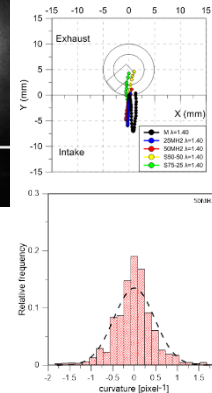
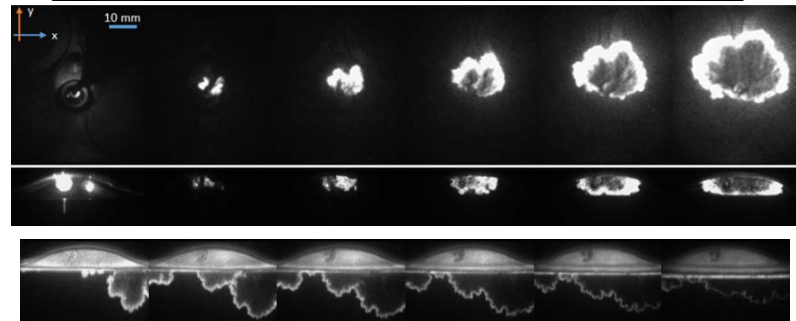

#### Scientific Impact/Results:

Custom image-processing was developed in the framework of international cooperation with Brazilian University. Results related to the macroscopic and microscopic analysis of the combustion process constituted a shared-database for the optimization of syngas fuelled engines.





# Project Area: Low emission energy technologies

## Bio and alternative fuels

### *Heavy duty engine powered with renewable fuels*

#### **Objective:**

Optimization of ignition parameters for heavy duty engine fueled with syngas of different compositions.

#### **Approach:**

The approach was mainly experimental on a multi-cylinder spark ignition turbocharged engine, operating at stoichiometric conditions. The fuel composition has a great influence on engine performance. The study analysed the combustion development and propagation varying the blends composition and the most important ignition parameters, such as current intensity and spark duration, as well as the spark advance. To control the fuel composition a dedicated device was realized for introducing into the engine inert species (N<sub>2</sub>, CO<sub>2</sub>) proportional to combustible species (NG and H<sub>2</sub>). The ratio of each species was set to simulate the right properties of syngas.

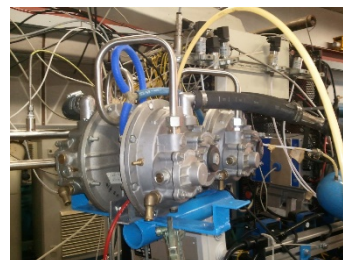

#### **Scientific Impact/Results:**

Definition of the optimal ignition parameters, such as electrode gap and spark energy for use of alternative gaseous fuels, of different composition, with the aim to improve not only in cylinder combustion propagation, but also the use of the resources to reduce the global CO<sub>2</sub> emissions.



# Project Area: Low emission energy technologies

## Bio and alternative fuels

### Objective:

Identification and overcoming of the technological issues and economic constraints regarding the adoption of bio and alternative LHV fuels in a commercial 100 kW micro gas turbine, aimed to a more rational exploitation of the available resources, while respecting the constraints imposed by a rational and sustainable exploitation of low-energy resources.

The interest in using a MGT is related to the possibility of feeding this system with a wide range of bio and alternative fuel mixtures and to realize efficient cogenerative cycles by recovering heat from exhaust gases at higher temperatures.

### Approach:

The activities are based on a synergistic approach between the numerical modelling and experimental analysis of a commercial machine installed in a test rig at the IM-CNR facility. The MGT is a 100 kWe Ansaldo-Turbec T100P, instrumented for run under different operating conditions and with different fuels. A plant for decompression and distribution of fuel gas mixtures allows to feed the combustor by gas mixtures with different composition. The fuel supply system can currently run gas mixture with variable percentage of  $\text{CH}_4$ ,  $\text{H}_2$ ,  $\text{CO}_2$  and  $\text{CO}$  in addition to the normal NG supply line.



View of the micro gas turbine installed at Istituto Motori - CNR in Naples (Turbec T100P). It is a single-shaft MGT which generates, by a regenerative cycle, 100 kW of electrical power with a global efficiency of 30%.

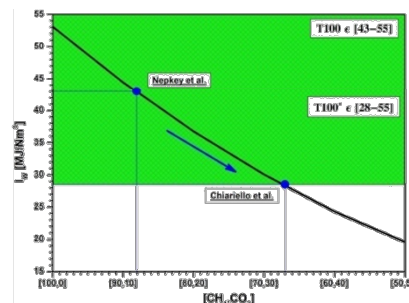

Extension of the domain of operation of a MGT for different alternative fuel mixtures (reduction of  $I_W$  lower limit).

### Scientific Impact/Results:

The research will help transform the current energy system into a more sustainable one, making it less dependent on imported traditional fuels. The end result will be a diverse mix of energy sources, in particular renewable ones, energy carriers and non-polluting sources. Energy efficiency, which includes rationalizing use and storage of energy, will be enhanced, thus addressing the pressing challenges of security of supply and climate change. Citizens will benefit from energy research through more affordable energy costs and through more efficient use of energies provided by different sources. Consequently, this will help reduce the causes of climate change, which will benefit everyone directly

# Project Area: Low emission energy technologies

## CO<sub>2</sub> capture and use: capture ready combustion systems

### Objective:

- Innovative combustion processes suitable for CO<sub>2</sub> sequestration:
- Oxyfiring of coal and biomass
- CLC of coal and solid fuels
- Carbloop of coal and residues with high metal content
- MILD combustion of fossil and bio-fuels
- Catalytic combustion
- Co-combustion of fossil and bio fuels

### Scientific Impact/Results:

- Fundamentals of combustion under unconventional conditions:
- mild combustion conditions; cyclic/looping conditions;
- oxycombustion atmospheres ; high pressure
- Catalysts of Chemical Looping
- Patents for CCS processes of solid fuels combustion (CarboLoop)

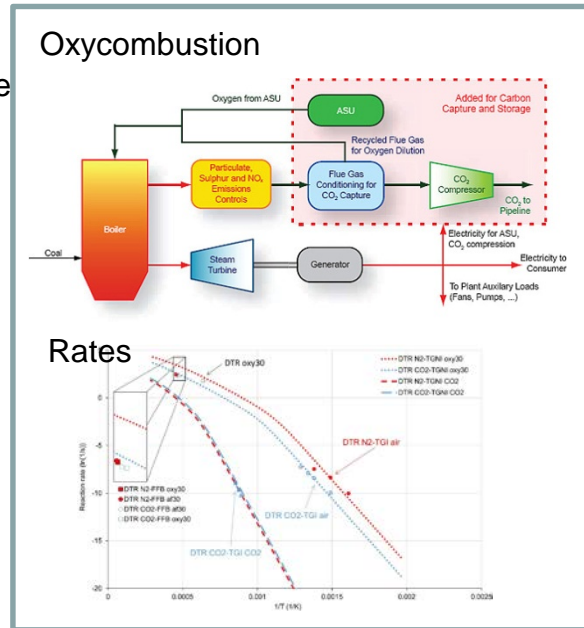
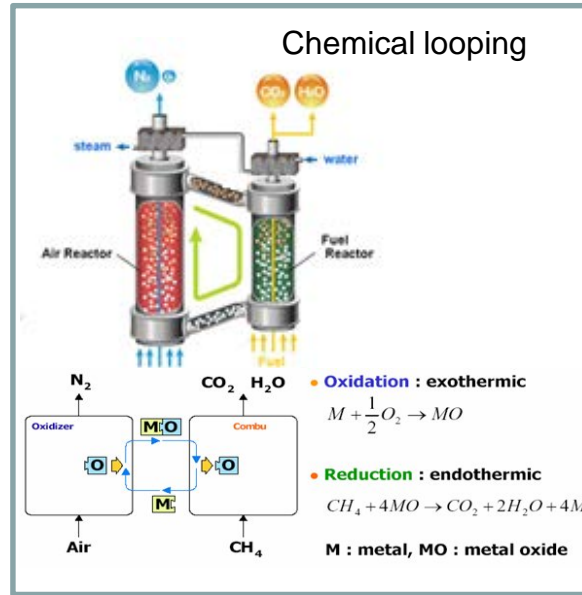
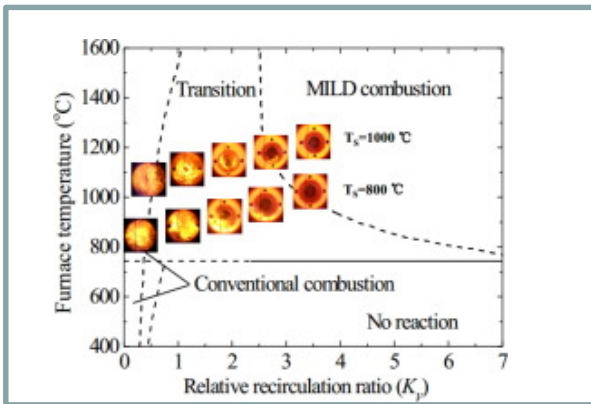

### Chemical looping of solids (CarboLoop)

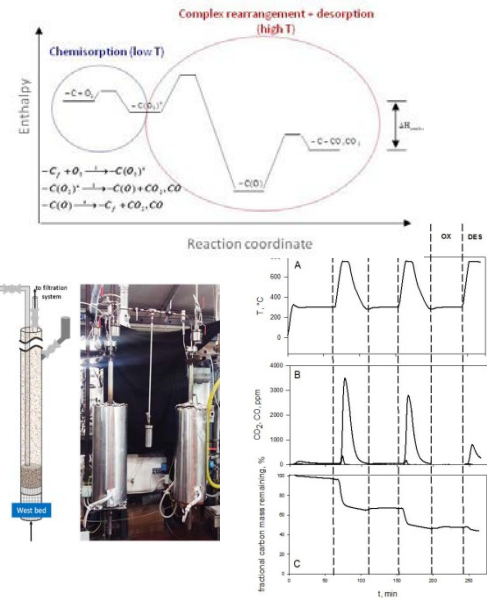
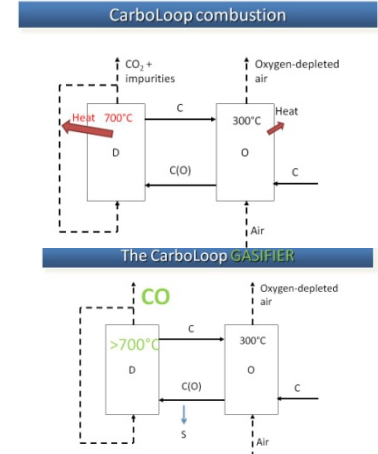



# Project Area: Low emission energy technologies

## CO<sub>2</sub> capture and use

### Objective:

Production of activated bio-carbons with a high surface area and remarkable CO<sub>2</sub> adsorption properties from pyrolysis of local residual biomasses and algae

### Approach:

- ✓ Pyrolysis experiments on raw material suitable to produce bio-char (reduced sulphur and ash contents);
- ✓ Chemical and physical activation steps depending of bio-char characteristics
- ✓ CO<sub>2</sub> adsorption isotherms measurements (Micromertics ASAP 2020)

### Scientific Impact/Results:

A CO<sub>2</sub> capture capacity value of 4.8 mmol/g was obtained by beached seaweed activated bio-char; it is among the highest reported, so far, for biomass-derived carbons.

### Figures:

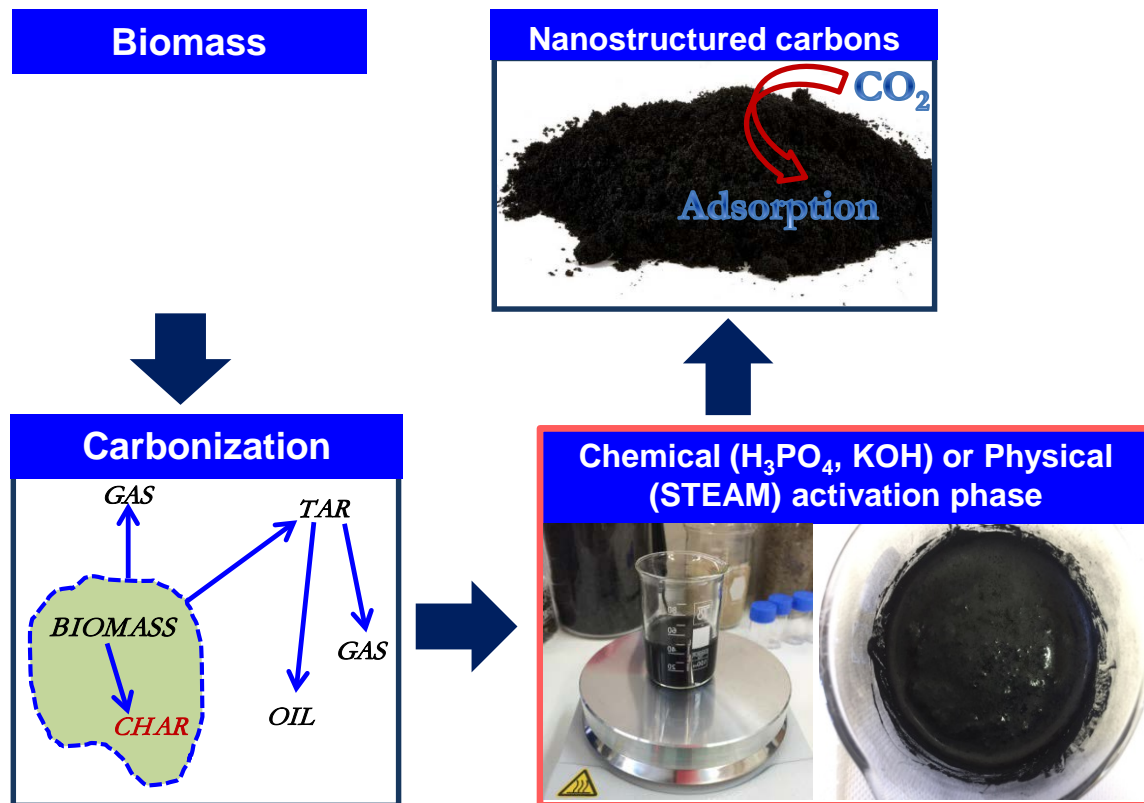





# Project Area: Low emission energy technologies

**CO<sub>2</sub> capture and use:** CO<sub>2</sub> to methane (PtG concept)

## Objective:

Development of advanced compact reactors for catalytic conversion of CO<sub>2</sub> into synthetic natural gas needed to scaling down the conventional processes (used at large scale for CO<sub>2</sub> conversion) for small-scale application and integration with hydrogen produced by the energy excess coming from renewable solar source (Power to Gas concept).

## Approach:

- The reactor design is based on the Process Intensification concept.
- The reactor integrates a structured catalyst and a cooling system with the aim to enhance crucial aspects such as surface-to-volume ratio, mass and heat transfer, control of pressure drop, catalyst lifetime and methane productivity to

## Scientific Impact/Results:

- Optimal control of the heat released by the exothermic methanation reaction (flat temperature profile along the catalytic bed)
- Improved life time of the catalyst (no deactivation by sintering and carbon deposition)
- Increased methane productivity (high performance at high space velocity,  $6\text{LCH}_4/\text{h}\cdot\text{cm}^3\text{react}$ )
- Combining separate unit operations such as reaction and cooling into a single piece of equipment resulting in a more efficient, cleaner, and economical manufacturing process.

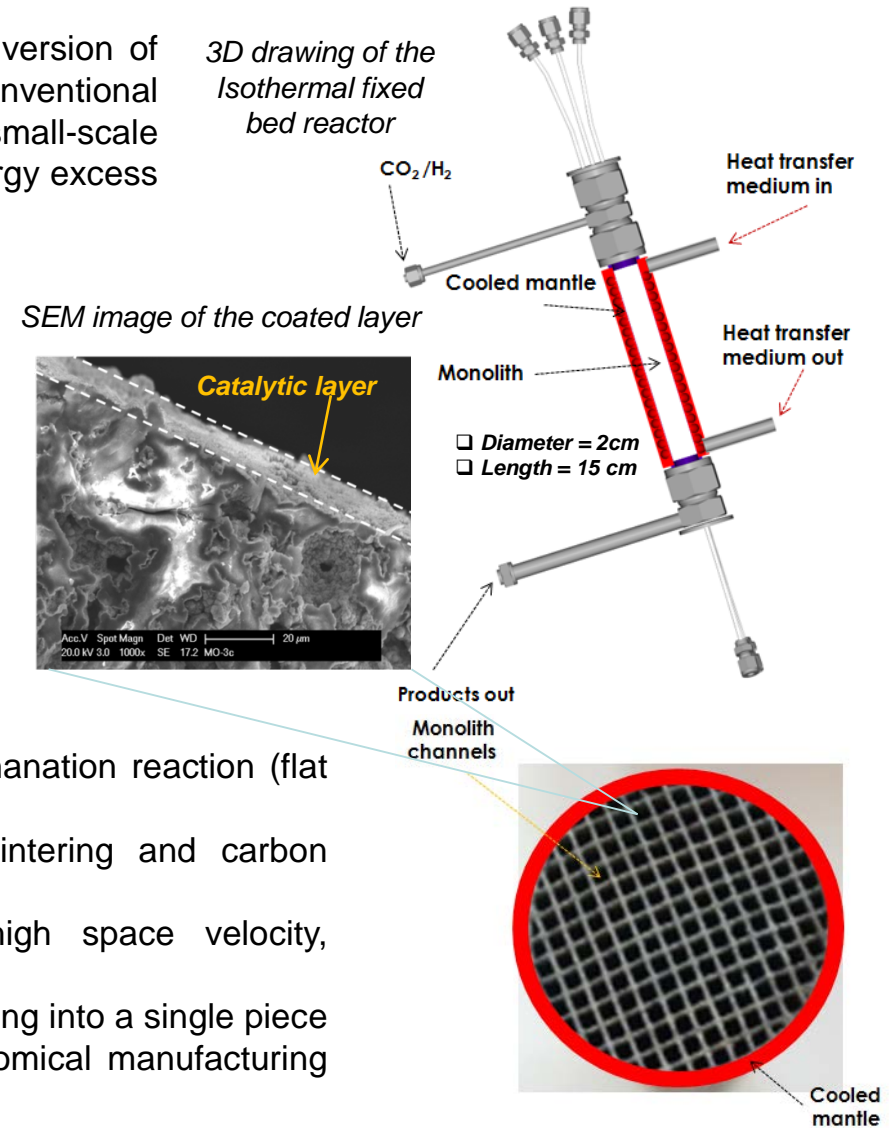



# Project Area: Low emission energy technologies

## CO<sub>2</sub> capture and use: CO<sub>2</sub> Enzymatic Reactive Absorption

### Objective:

The research activity is aimed at the development of the process for **CO<sub>2</sub> capture through Enzymatic Reactive Absorption (ERA)** using K<sub>2</sub>CO<sub>3</sub> solutions as aq solvents and recombinant thermostable carbonic anhydrase as biocatalyst to enable CO<sub>2</sub> capture from flue gases

### Approach:

Development CO<sub>2</sub> Enzymatic Reactive Absorption (ERA) through:

#### Process simulation

#### Reactor design (absorption contact units)

#### Biocatalyst development (immobilized carbonic anhydrase - CA)

- **CA immobilization** by different covalent technique to obtain slurry (fine dispersed particles) biocatalyst allowing effective absorption rate enhancement at gas-liquid interface
- **Kinetic characterization** of both free and immobilized CA
- The reactor design through **theoretical modelling of ERA units** including experimentally assessed kinetic parameters for both free and immobilized CA

### Scientific Impact/Results:

- 90% immobilization yield of CA in magnetic Cross-Linked Enzyme Aggregates, 73% immobilization yield of CA through direct binding on magnetic NPs.
- Kinetic characterization of both free CA and CA immobilized on magnetic NPs at industrially relevant conditions (solvent composition, temperature).
- Performances of slurry staged ERA units by theoretical modelling based on experimentally assessed kinetics of CA immobilized on magnetic NPs → pilot bubble column with capture efficiency between 67-99% depending on solid biocatalyst hold-up (2-0.1%vol)

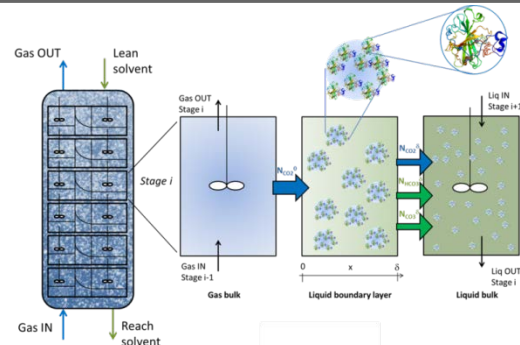
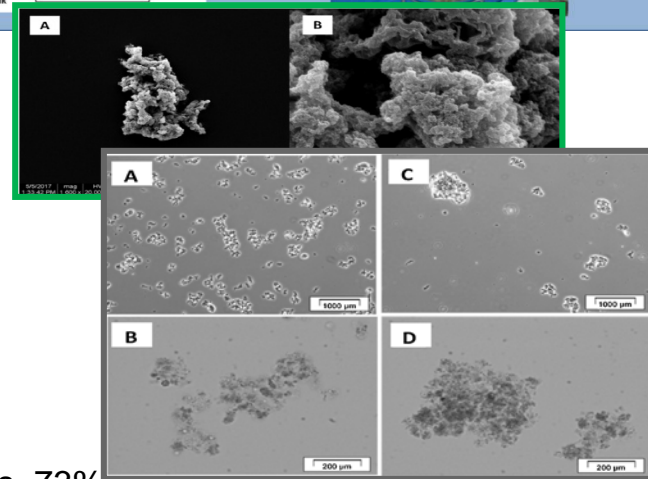
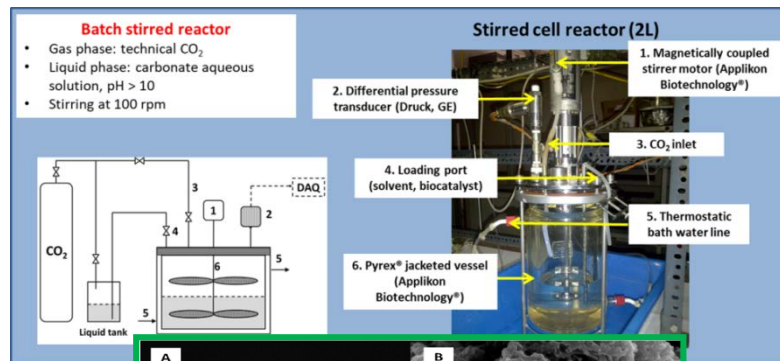



# Project Area: Low emission energy technologies

## CO<sub>2</sub> capture and use: development of sound assisted fluidized bed technology for CO<sub>2</sub> capture

### Objective:

Fluidized bed technologies allow efficient gas-solid contact and intense solid mixing, easier temperature control during both adsorption and regeneration, indirect heating by internal heat exchanger and lower pressure drop needed for reactor design. **Sound assisted fluidized bed technology** is able to dynamically brake up large agglomerate of particles into small fluidizable aggregates avoiding plugging, channeling and agglomeration typical of fine powders.

### Approach:

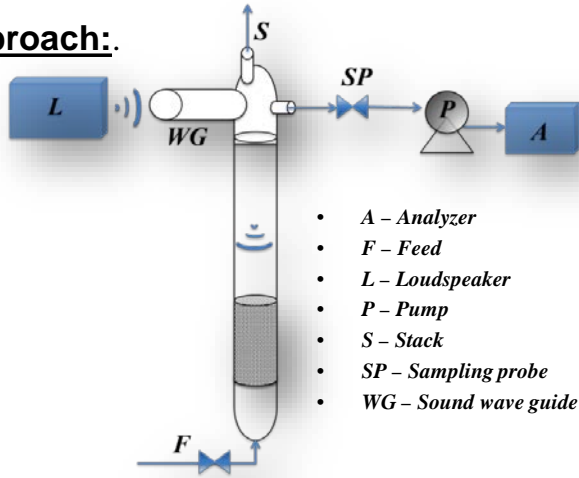

### Scientific Impact/Results:

Effect of sound

- ✓ More regular pressure drop ( $DP/DP_0 \Rightarrow 1$ )
- ✓ Higher bed expansion ratios
- ✓ Not intrusive
- ✓ Fine powders do not need to have any peculiar property
- ✓ Economic and user - friendly

### Figures:

Experimental Apparatus

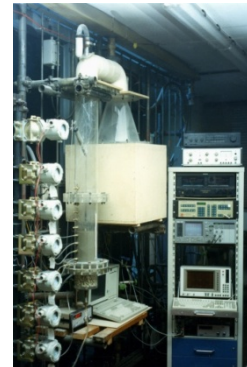

No sound



sound assisted fluidization



In-situ sorbent regeneration

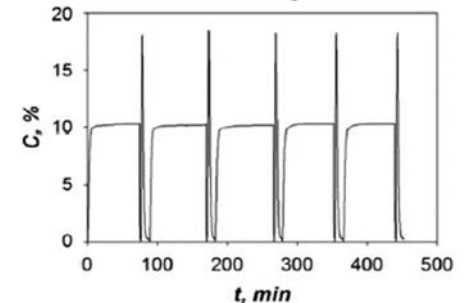

# Project Area: Low emission energy technologies

## CO<sub>2</sub> capture and use: CaL-CSP process

### Objective:

The study of the integration of Calcium looping process with concentrated solar power for CO<sub>2</sub> capture and thermochemical storage to increase power flexibility

### Approach:

### Integration scheme

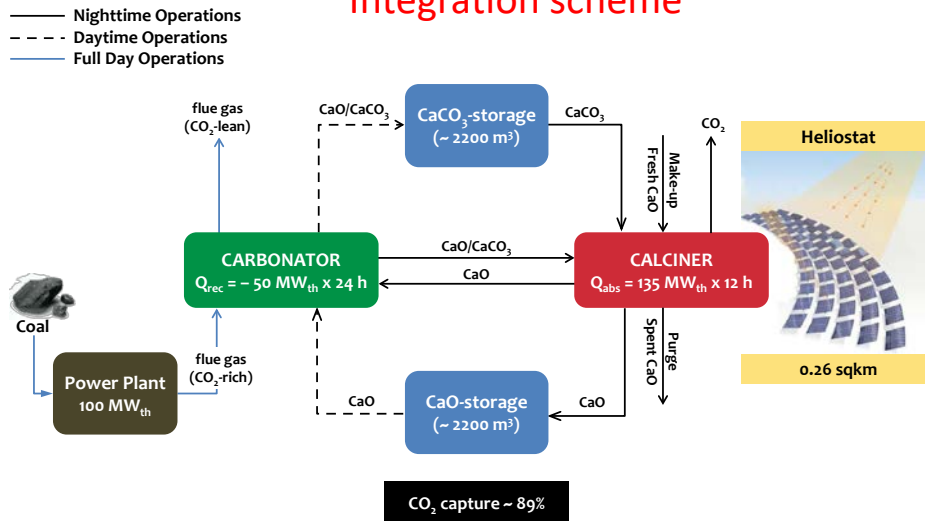

### Figures:

Interconnected fluidized bed configuration proposed

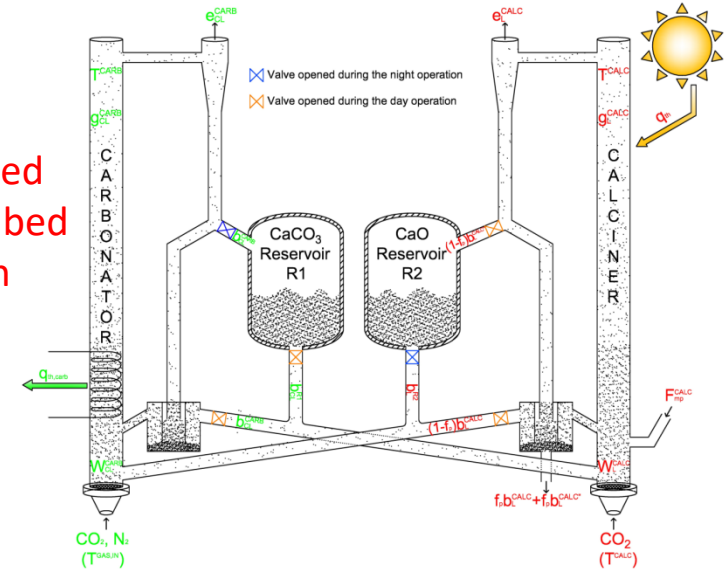

### Scientific Impact/Results:

CO<sub>2</sub> capture and carbonation conversion degree over iterated cycles





# Project Area: Low emission energy technologies

## CO<sub>2</sub> capture and use: production of advanced solid sorbent materials with enhanced CO<sub>2</sub> capture efficiency

### Objective:

Development and tailoring of advanced nanostructured solid sorbents (also composites, hybrids and magnetic particles) with physical and chemical properties finely tunable at the molecular level by eco-friendly wet-chemistry approaches.

### Approach:

Carbonaceous materials typically present structural features prone to be easily modified at molecular level. We mostly use **green solvents** (water) and develop **cost-effective** protocols (the precursors are easily available and not expensive) and simple synthesis procedure (i.e. anhydrous conditions not required) starting from carbonaceous materials (carbon black, carbon-based pollutants) also from **agricultural wastes** (carbonized and pyrolyzed biomasses).

Wet-chemistry approaches are specifically developed to preserve the **conductive** properties of the carbonaceous core.

### Scientific Impact/Results:

- A wide array of advanced low-cost water stable solid sorbents for CO<sub>2</sub> capture has been produced and tested in **real condition** (breakthrough experiments);
- Sorbent are produced by tuning surface area (up to 2700m<sup>2</sup>/g in the case of MOF) and micro-meso pore size distribution.
- **Recyclable (thermal desorption allows production of CO<sub>2</sub> ultra pure streams);**
- Suitable for technological advanced application (sound assisted fluidized bed reactors);
- A  $m_{ads} = 25 \text{ mg}_{CO_2}/\text{g}$  in real post conditions CO<sub>2</sub>/N<sub>2</sub> gas mixture (15 NI/h) at a fixed CO<sub>2</sub> concentration (3% vol) was measured (best case).

### Figures:

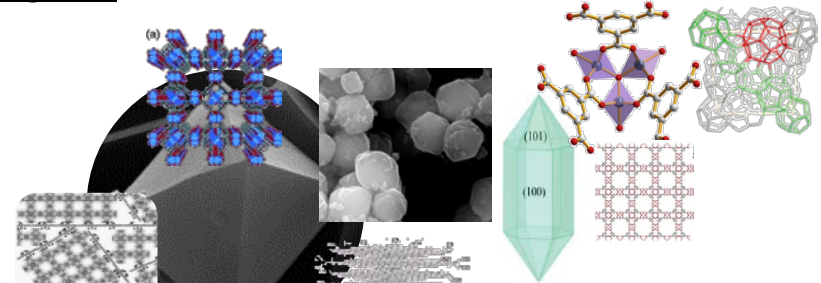

**Metal organic framework (MOF)/graphene-like composites (Fe, Cu, Zn, Al Ti- based)**

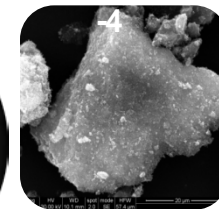
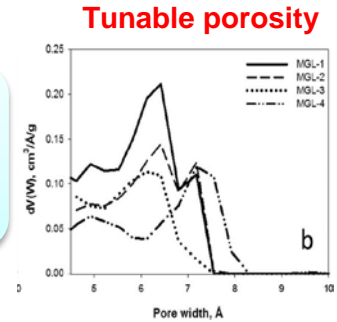

**Magnetite loaded carbon fine particles and carbonized biomasses**

- Chemi and physisorption phenomena
- Fe<sub>2</sub>O<sub>3</sub> dispersion on a carbonaceous support limits the Fe<sub>2</sub>O<sub>3</sub> tendency to aggregate
- magnetic



# Project Area: Low emission energy technologies

## Cooling and Heating: HVAC&R systems and components

### Objective:

- Improve energy efficiency and environmental sustainability of components and systems for the HVAC&R sector and household appliances.

### Approach:

- Components: numerical and experimental thermo-fluid-dynamic analysis of heat exchangers, fans, refrigerated display cabinets, fan-coils, etc.
- Systems: numerical performance evaluation, principle design, test and field data processing of refrigerating units for supermarkets and heat pumps and chillers for residential, commercial, industrial applications.
- Refrigerants: use of natural refrigerants (carbon dioxide) in refrigeration systems and heat pumps.

### Scientific Impact/Results:

- Introduce innovation and promote fast implementation of energy efficient heating and cooling solutions for the HVAC&R sector.
- Demonstrate of the next generation standardised integrated cooling and heating packages for commercial and public buildings based on environment-friendly carbon dioxide vapour compression cycles.

### Figures:

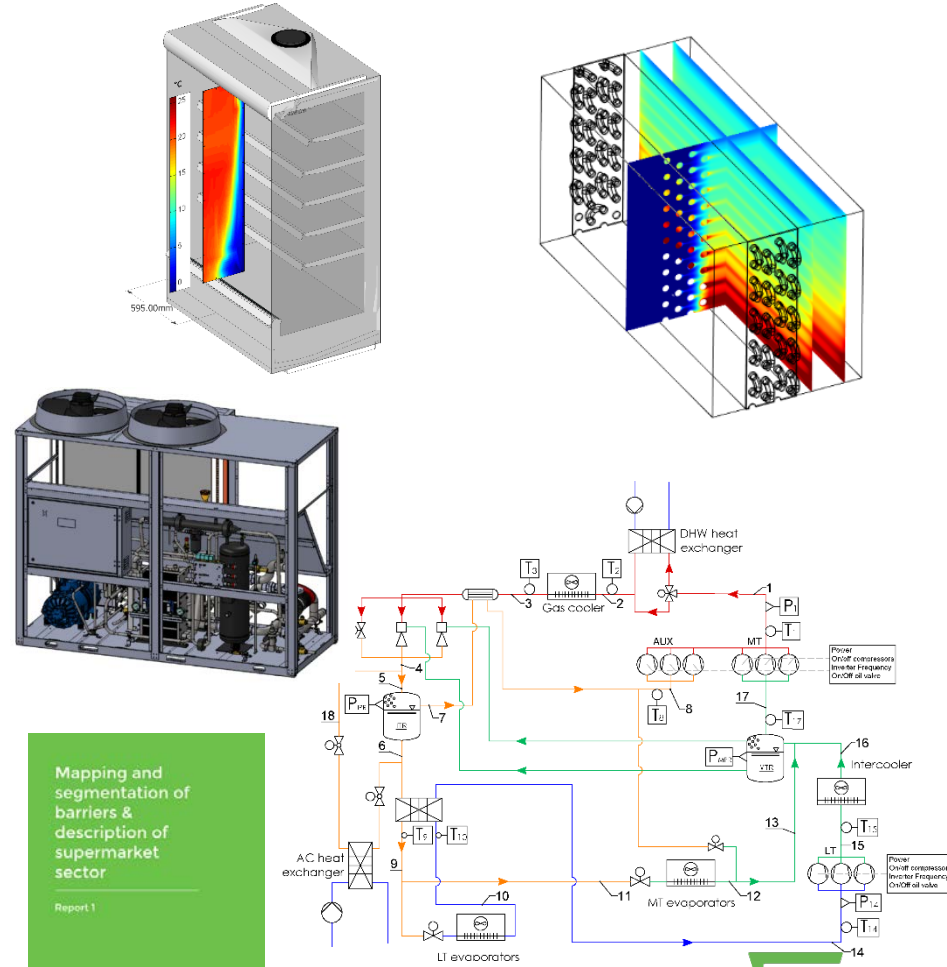

The SuperSmart project has received funding from the European Union's Horizon 2020 research and innovation programme under grant agreement N° 696076.



The MultiPACK project has received funding from the European Union's Horizon 2020 research and innovation programme under grant agreement N° 723137.



**SUPERSMART**



**multi  
PACK**



# Project Area: Low emission energy technologies

## Cooling and Heating: Low GWP Refrigerants and PCMs

### Objective:

#### **Low GWP Refrigerants**

The reduction of the negative environmental impacts of working fluids in refrigeration is a strict demand of the market, due to the several regulations against ODP and GWP fluids.

#### **PCMs and nano-PCMs**

PCMs for energy storage have become of crucial importance in the strategy for energy and environmental sustainability. Their characterization is necessary to understand their capability to manage thermal energy.

### Approach:

#### **Low GWP Refrigerants**

Beyond natural fluids, a few HFCs and a dozen of HFOs, are potentially appropriate for a number of HVACR applications. The study of HFOs, fluorinated olefins characterized by the presence of a C=C double bond in the molecule, is really important to define their performance in the final applications.

#### **PCMs and nano-PCMs**

PCMs characterization is necessary to understand their capability to manage thermal energy.

### Scientific Impact/Results:

### Figures:

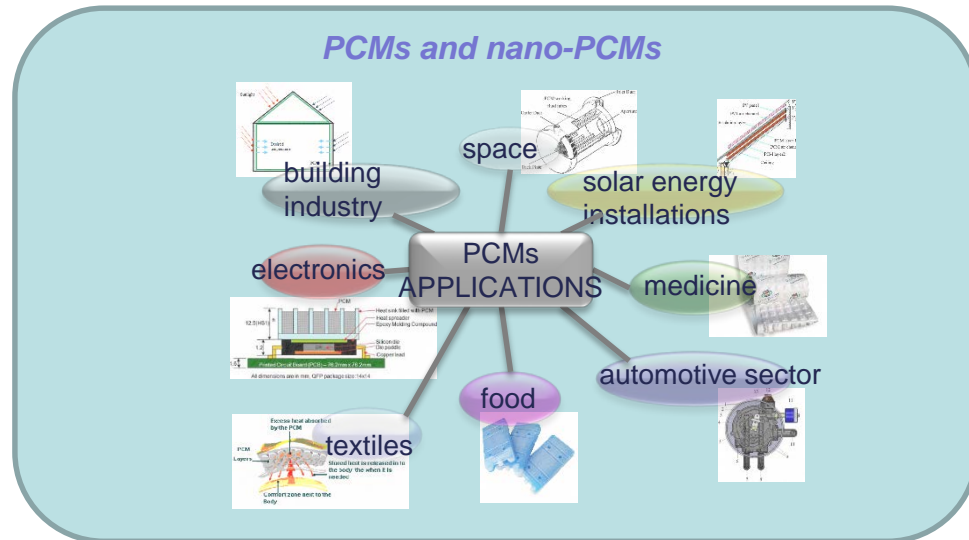
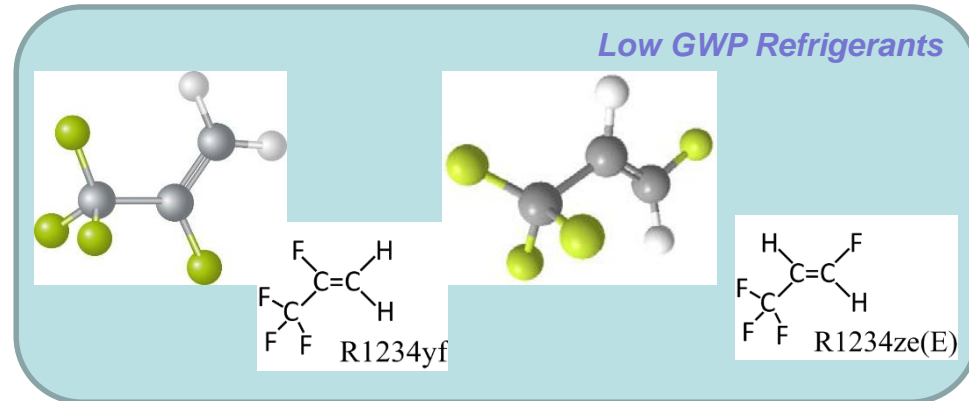

GEO4CIVHIC: "Most Easy, Efficient and Low Cost Geothermal Systems for Retrofitting Civil and Historical Buildings"



# Project Area: Low emission energy technologies

**Cooling and Heating:** Diagnostics, energy saving and eco-sustainability in buildings

## Objective:

### **Photocatalysis**

Activity measurement of heterogeneous photocatalysts in gas/solid and liquid/solid phase applied to the development of special photocatalysts for sustainable construction materials.

### **Diagnostics**

Embedding the waste from building demolition in a geopolymer matrix to produce prefabricated radiant heating panels for cooling and heating

## Approach

### **Photocatalysis**

Development of specialized analytical systems for photocatalytic activity measurements in gas/solid and liquid/solid phase.

### **Diagnostics**

IR thermography applied to enhance the performance evaluation of radiant heating/cooling panels beyond the standardized enthalpy test

## Scientific Impact/Results

Various collaborations with Universities and research Institutes with several published papers. Participation to the INTEGRATE and I-ZEB projects financed by Regione Lombardia.



InnoWEE Innovative pre-fabricated components including different waste construction materials reducing building energy and minimising environmental impacts Grant Agreement number 723916



## **Figures:**

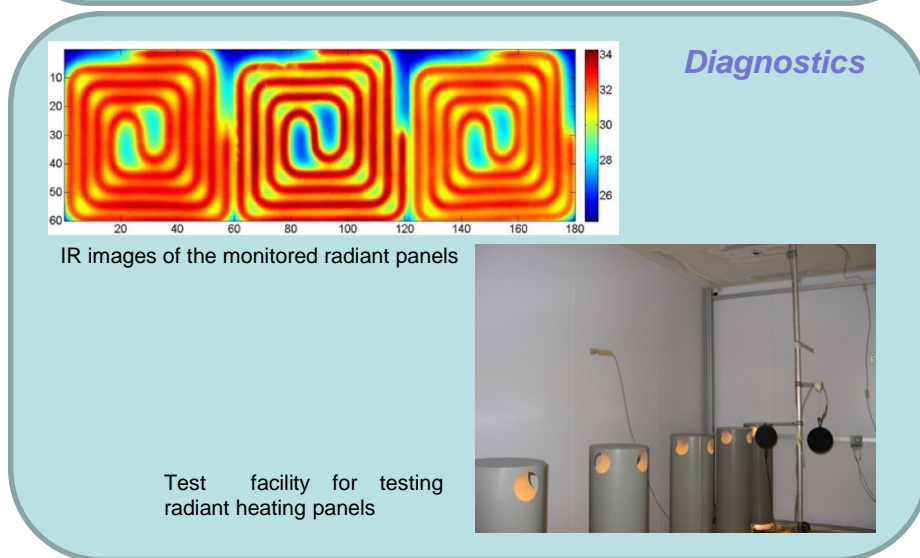
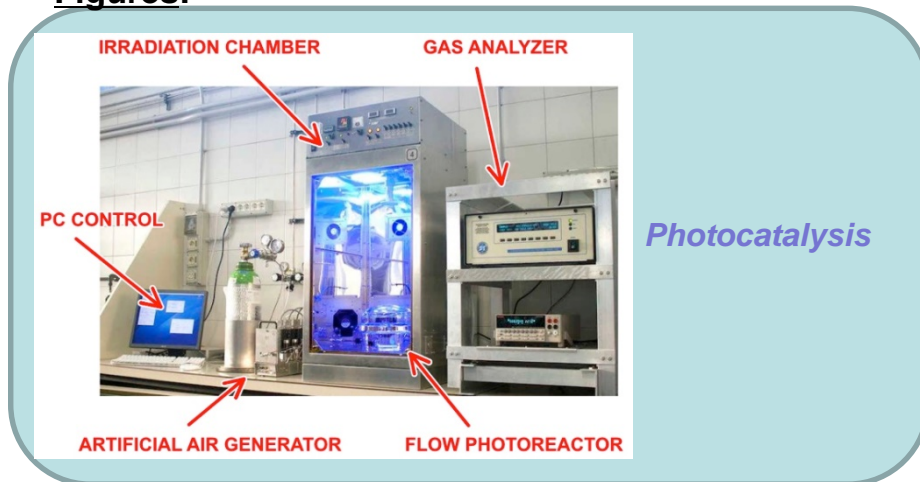





# Project Area: Low emission energy technologies

## Cooling and Heating: Solar cooling and heating



Consiglio Nazionale delle Ricerche  
Engineering, ICT and Technologies for  
Energy and Transportation Department

### Objective:

- Increasing the share of renewables at building scale;
- Development of innovative hybrid solutions for solar heating, cooling and storage.

### Approach:

- Simulation of different system layouts, design and testing of an integrated hybrid sorption/compression machine for cooling applications
- Optimization of components and systems for hybrid electric/thermal storage solutions for domestic applications;
- Realization of prototypes and validation in relevant environments (TRL 5).

### Scientific Impact/Results:

- Design and testing of a hybrid chiller, characterized by an electrical COP up to 6.0, under typical operating space cooling operating conditions;
- Modelling of fully integrated hybrid electric/thermal energy storage systems for Mediterranean and Continental climates.

### Figures:

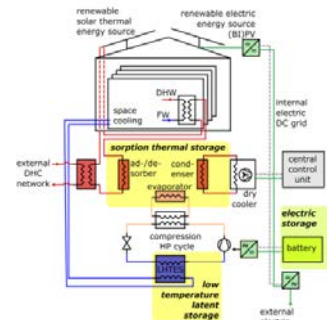
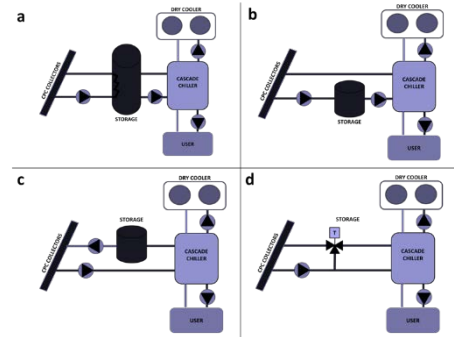

Mediterranean system

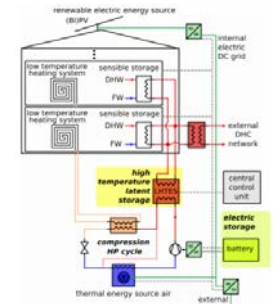

Continental system



The Zeosol project has received funding from the European Union's Horizon 2020 research and innovation programme under grant agreement N° 760210.

The Hybuild project has received funding from the European Union's Horizon 2020 research and innovation programme under grant agreement N° 768824.

# **Fossil fuels and new concepts for clean combustion**

- **Efficiency of thermal power/combustion**
- **Emission control**
- **Fuel and operational flexibility**
- **New concepts and capture ready combustion**
- **CO<sub>2</sub> capture and use**

**Objective:**

**Detailed chemico-physical Analysis of liquid and solid fuels;**

**Understand the thermochemical behavior of solid and liquid fuels;**

**Assess reaction kinetics and networks**

**Microstructural and chemico-physical analysis of solids**

(Porosimetric analysis, SEM, TEM, XPS, XRD, Raman)

**Kinetics of solid fuels reactions under a wide range of conditions**

(TGA/DSC coupled with MS or FTIR, fixed beds, suspension firing, pressurized heated strip reactor, fluidized beds)

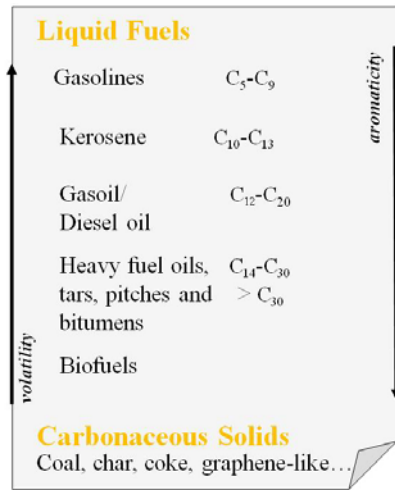

- Volatility, Distillation, oxidation reactivity, Coking yield, Conradson residue by **Thermogravimetry** (TGA, Perkin Elmer)
- Metal and inorganic content by **ICP-MS** (Agilent Technology)
- Molecular weight distribution and functional groups determination by **mass spectrometry** (GC-MS, Ion Trap-MS, Agilent Technology)
- Aliphatic and Aromatic Hydrocarbons distribution by **Liquid and Gas-chromatography** (GC, GC-MS, HPLC, Agilent Technology)
- Polycyclic aromatic hydrocarbons content and BaP equivalent (carcinogenic index) by **Gas-chromatography/Mass spectrometry** (GC-MS, Agilent Technology)
- **Elemental Analysis** (C,H,N,S content) (LECO)
- Aromaticity and oxygen content by **Infrared, UV-Vis and fluorescence spectroscopy** (FT-IR, ThermoFisher, UV-Vis Absorption, Agilent Technology, UV-Vis Fluorescence, Perkin Elmer)
- Solubility by **solvent extraction**
- Amorphous/graphenic degree by **Raman spectroscopy** (Horiba XploRA)

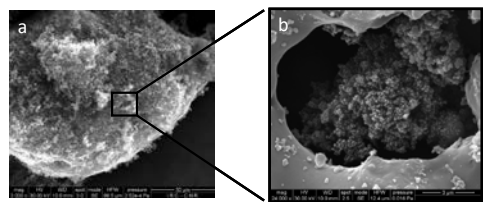
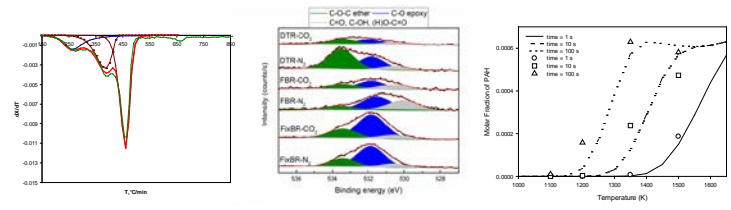
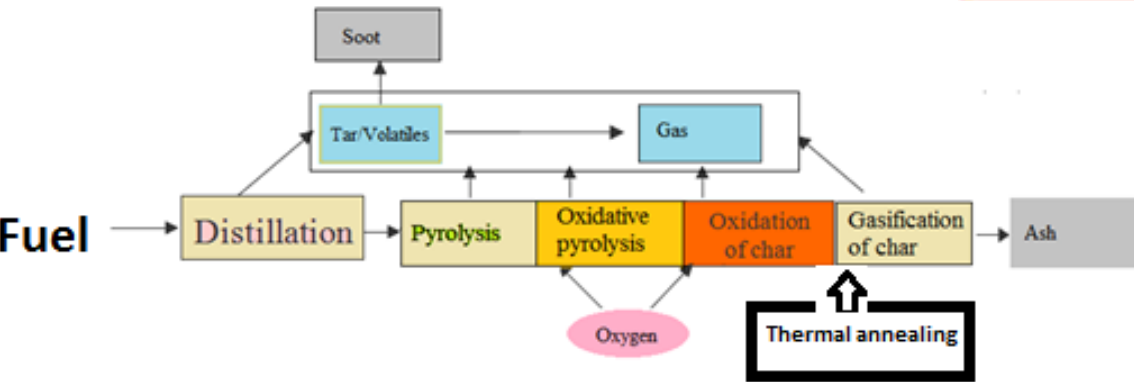



# Project Area: Low emission energy technologies

## Clean combustion:

Efficiency of thermal power/combustion



Consiglio Nazionale delle Ricerche  
Engineering, ICT and Technologies for  
Energy and Transportation Department

### Objective

To sustain technological development of thermal power plants in the scenario of intermittent operation and diversification of fuels

### Approach:

- Flames diagnostics
- Atomization and sprays
- Turbulent flow mixing
- Fluid-dynamics of multiphase reactors
- Single particles reaction modeling
- Reaction kinetics under steady and dynamic operation
- Dynamics of granular systems
- Dynamics of fluidized bed reactors
- Dinamics of non linear processess

### Figures:

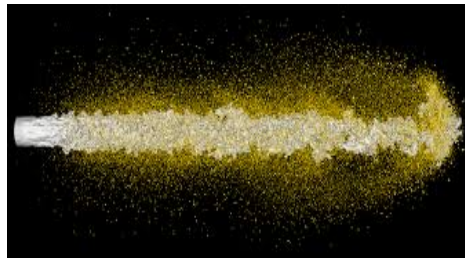
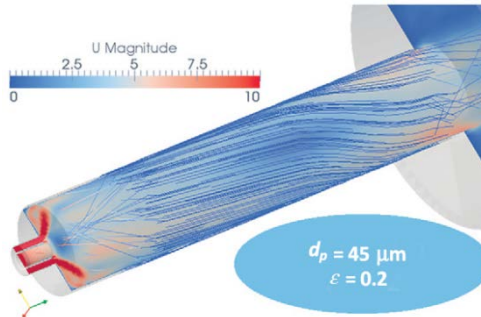
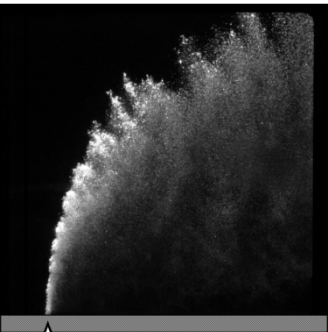
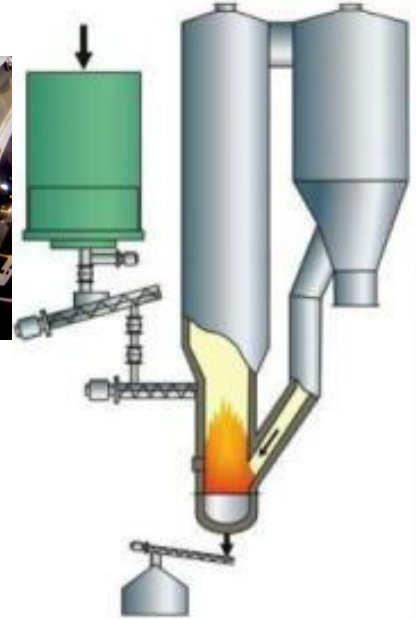
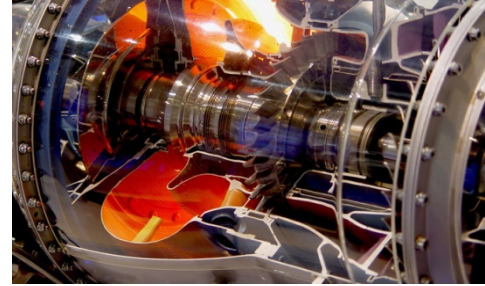

### Scientific Impact/Results:

- Fundamentals of combustion
- Fundamentals of reactor design
- Detailed kinetics
- Fragmentation/annealing/Particles-wall interaction
- Optimization of reactor design
- Increase of efficiency, minimization of environmental impact





# Project Area: Low emission energy technologies

**Clean combustion:**  
Emission control

## Objective:

•Change in fuel composition or energy mix influence the design of the conversion system but also pollutants. It is urgent to improve knowledge on Formation mechanisms of new pollutants, and develop new diagnostics and abatement methodology.

## Approach:

Research activities are focused on:

1. Formation mechanisms of pollutants;
2. Advanced diagnostics for regulated / unregulated pollutants;
3. Reduction of pollutants from fossil and alternative fuels.

Specific activities include in-situ, on-line and off line advanced diagnostics of pollutants and ultrafine particles; diagnostic of flame instabilities; NO<sub>x</sub>, SO<sub>x</sub> and particulate reduction; SCR; Combined particulate and NO<sub>x</sub> reduction; NO<sub>x</sub> storage-decomposition for automotive application; PM reduction through water vapor condensation; Hg capture from flue gases; purification of CO<sub>2</sub> streams; tar and VOC abatement.

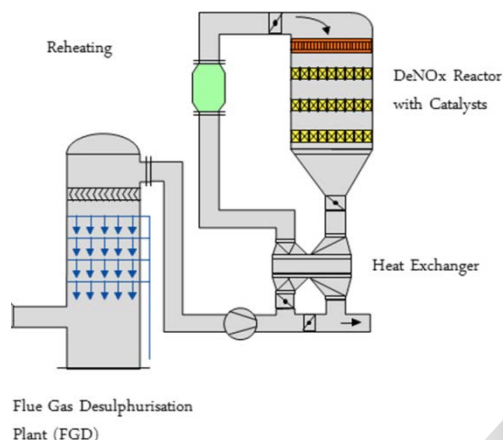

## Figures:

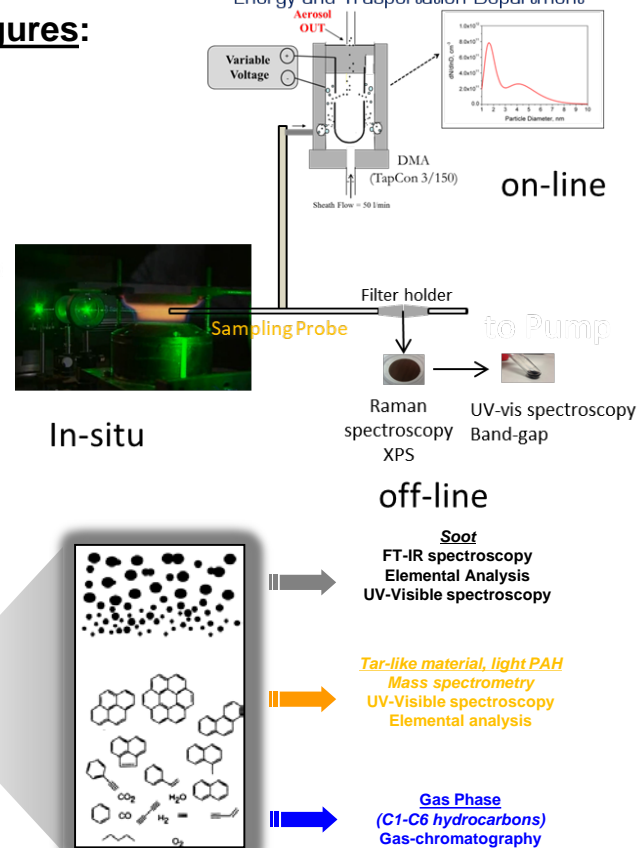

## Scientific Impact/Results:

- Physicochemical characterization of combustion generated carbon nanoparticles
- Characterization of main combustion products and intermediates
- Intensification of catalytic processes and development of novel materials



# Project Area: Low emission energy technologies

**Clean combustion:**

Operational and fuel flexibility



Consiglio Nazionale delle Ricerche  
Engineering, ICT and Technologies for  
Energy and Transportation Department

## Objective:

Development of innovative combustion technologies to meet the need of:

-Operational **flexibility and efficiency** in a wide minimum/maximum and variable load range (minimum load, hot/cold start, ramp rate)

-**Fuel flexibility** for the **exploitation of** energy carriers derived from locally available resource and from **chemical energy storage**

For supporting the low carbon economy and the exploitation of variable renewable energy resource

## Approach:

Identification of

- new paradigms: **MILD Combustion** (flameless, noiseless, no or extremely low pollutant emission)
- Innovative “scale bridging” configurations

Exploration of :

- wide ranges of operational parameters (power, temperature, pressure, dilution, oxygen concentration)
- standard and **new energy carriers** (carbon based and no carbon fuels, like **Hydrogen** and **Ammonia**)



**NH<sub>3</sub>**

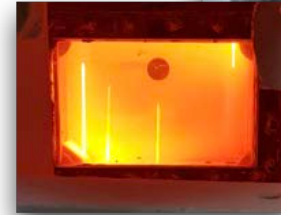

**CH<sub>4</sub>**

**Laboratory Unit CYclonic burner**

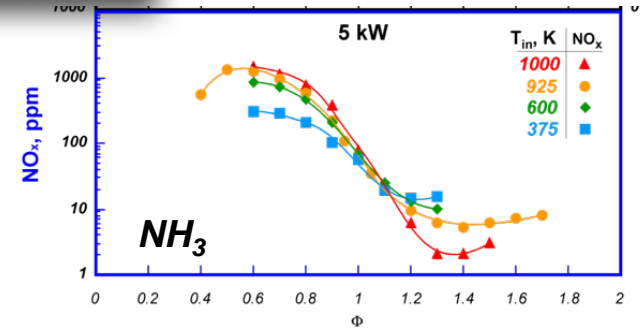

## Scientific Impact/Results:

- MILD Cyclonic burner technology validated in lab (TRL4-5)
- Optimization of tools for modeling and design of innovative combustion processes (kinetic models, advanced reactive turbulent system modeling, turbulence-chemistry interaction models)
- Characterization of Elementary reactive structures in MILD/flameless conditions



# Project Area: Low emission energy technologies

## Clean combustion:

### New concepts and capture ready combustion



Consiglio Nazionale delle Ricerche  
Engineering, ICT and Technologies for  
Energy and Transportation Department

#### Objective:

- Innovative combustion processes:
- MILD combustion of fossil and bio-fuels
- Catalytic combustion
- Co-combustion of fossil and bio fuels
- Oxyfiring of coal and biomass
- CLC of coal and solid fuels
- CarboLoop of coal and residues with high metal content

#### Scientific Impact/Results:

Fundamentals of combustion under unconventional conditions:  
 mild combustion conditions; cyclic/looping conditions;  
 oxycombustion atmospheres ; high pressure  
 Catalysts of Chemical Looping  
 Patents for CCS processes of solid fuels combustion (CarboLoop)

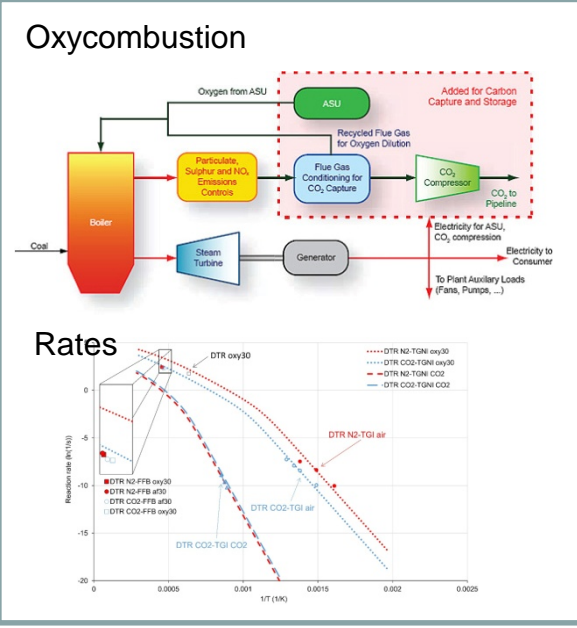
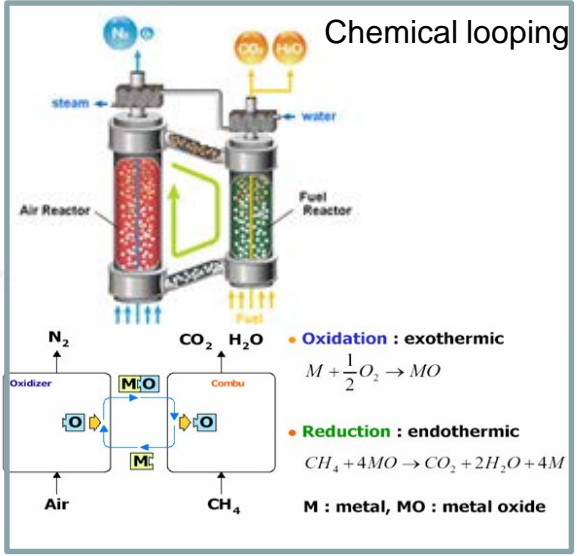
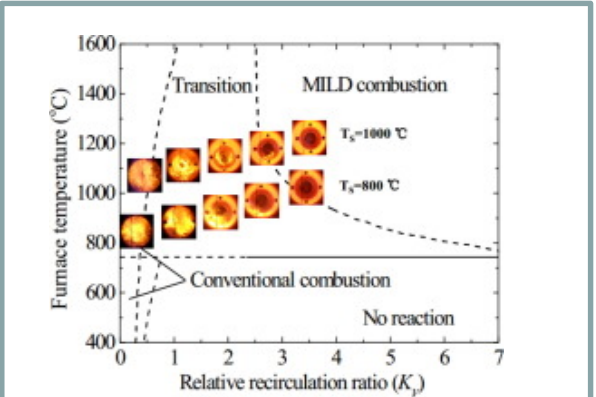

## CarboLoop: chemical looping of solids without use of metal oxygen carriers

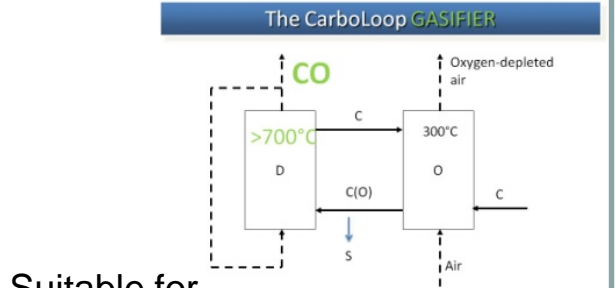
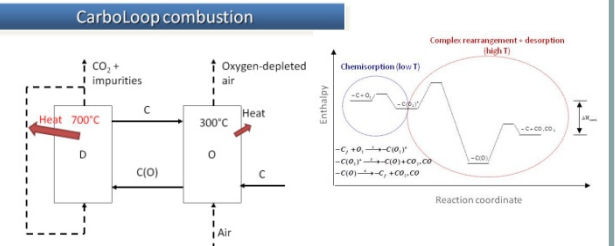

## Suitable for METAL RECOVERY from REFINERY RESIDUES

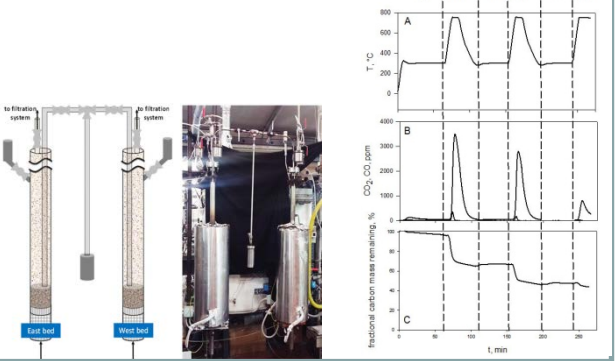



### Objective:

Development and tailoring of advanced nanostructured solid sorbents (also composites, hybrids and magnetic particles) with physical and chemical properties finely tunable at the molecular level by eco-friendly wet-chemistry approaches.

### Approach:

Carbonaceous materials typically present structural features prone to be easily modified at molecular level. We mostly use **green solvents** (water) and develop **cost-effective** protocols (the precursors are easily available and not expensive) and simple synthesis procedure (i.e. anhydrous conditions not required) starting from carbonaceous materials (carbon black, carbon-based pollutants) also from **agricultural wastes** (carbonized and pyrolyzed biomasses).

Wet-chemistry approaches are specifically developed to preserve the **conductive** properties of the carbonaceous core.

### Scientific Impact/Results:

- A wide array of advanced low-cost water stable solid sorbents for CO<sub>2</sub> capture has been produced and tested in **real condition** (breakthrough experiments);
- Sorbent are produced by tuning surface area (up to 2700m<sup>2</sup>/g in the case of MOF) and micro-meso pore size distribution.
- **Recyclable (thermal desorption allows production of CO<sub>2</sub> ultra pure streams);**
- Suitable for technological advanced application (sound assisted fluidized bed reactors);
- A  $m_{ads} = 25 \text{ mg}_{CO_2}/\text{g}$  in real post conditions CO<sub>2</sub>/N<sub>2</sub> gas mixture (15 NI/h) at a fixed CO<sub>2</sub> concentration (3% vol) was measured (best case).

### Figures:

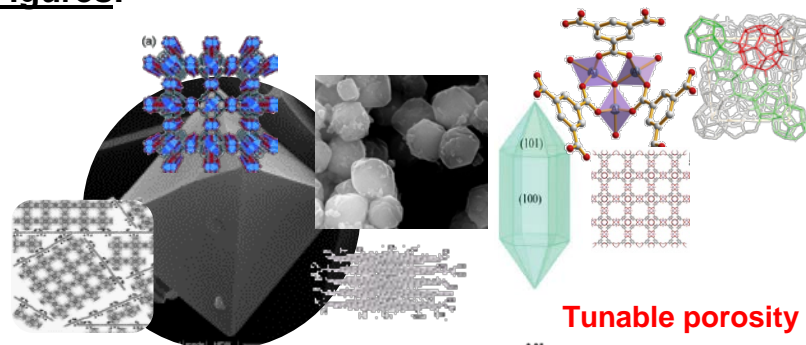

**Metal organic framework (MOF)/graphene-like composites (Fe, Cu, Zn, Al Ti- based)**

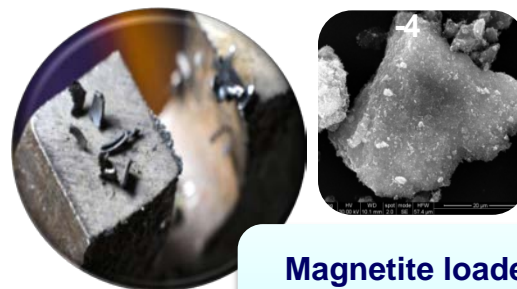
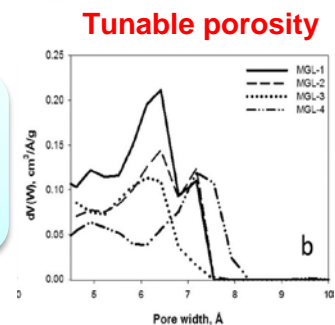

**Magnetite loaded carbon fine particles and carbonized biomasses**

- Chemi and physisorption phenomena
- Fe<sub>2</sub>O<sub>3</sub> dispersion on a carbonaceous support limits the Fe<sub>2</sub>O<sub>3</sub> tendency to aggregate
- magnetic





# Project Area: Low emission energy technologies

## Clean combustion:

### CO<sub>2</sub> capture

### Objective:

Fluidized bed technologies allow efficient gas-solid contact and intense solid mixing, easier temperature control during both adsorption and regeneration, indirect heating by internal heat exchanger and lower pressure drop needed for reactor design. **Sound assisted fluidized bed technology** is able to dynamically brake up large agglomerate of particles into small fluidizable aggregates avoiding plugging, channeling and agglomeration typical of fine powders.

### Approach:

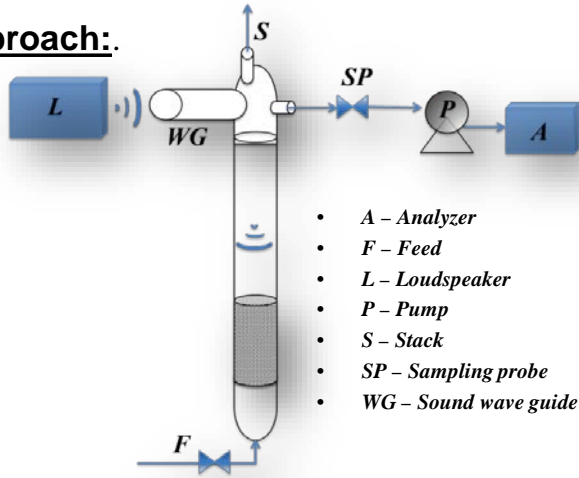

### Scientific Impact/Results:

#### Effect of sound

- ✓ More regular pressure drop ( $DP/DP_0 \Rightarrow 1$ )
- ✓ Higher bed expansion ratios
- ✓ Not intrusive
- ✓ Fine powders do not need to have any peculiar property
- ✓ Economic and user - friendly

### Figures:

Experimental Apparatus

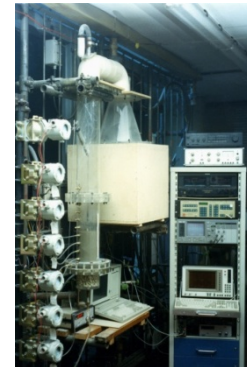

No sound



sound assisted fluidization

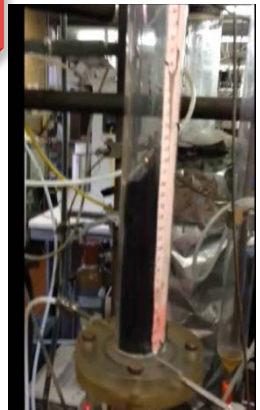

In-situ sorbent regeneration

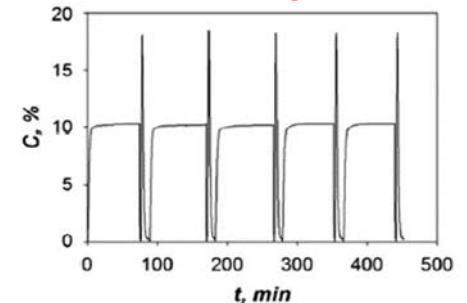



### Objective:

The research activity is aimed at the development of the process for **CO<sub>2</sub> capture through Enzymatic Reactive Absorption (ERA)** using K<sub>2</sub>CO<sub>3</sub> solutions as aq solvents and recombinant thermostable carbonic anhydrase as biocatalyst to enable CO<sub>2</sub> capture from flue gases

### Approach:

Development CO<sub>2</sub> Enzymatic Reactive Absorption (ERA) through:

#### Process simulation

#### Reactor design (absorption contact units)

#### Biocatalyst development (immobilized carbonic anhydrase - CA)

- **CA immobilization** by different covalent technique to obtain slurry (fine dispersed particles) biocatalyst allowing effective absorption rate enhancement at gas-liquid interface
- **Kinetic characterization** of both free and immobilized CA
- The reactor design through **theoretical modelling of ERA units** including experimentally assessed kinetic parameters for both free and immobilized CA

### Scientific Impact/Results:

- 90% immobilization yield of CA in magnetic Cross-Linked Enzyme Aggregates, 73% immobilization yield of CA through direct binding on magnetic NPs.
- Kinetic characterization of both free CA and CA immobilized on magnetic NPs at industrially relevant conditions (solvent composition, temperature).
- Performances of slurry staged ERA units by theoretical modelling based on experimentally assessed kinetics of CA immobilized on magnetic NPs → pilot bubble column with capture efficiency between 67-99% depending on solid biocatalyst hold-up (2-0.1%vol)

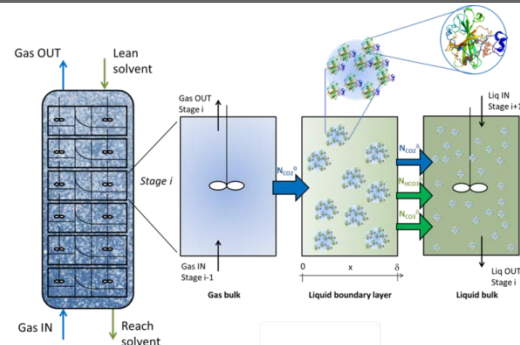
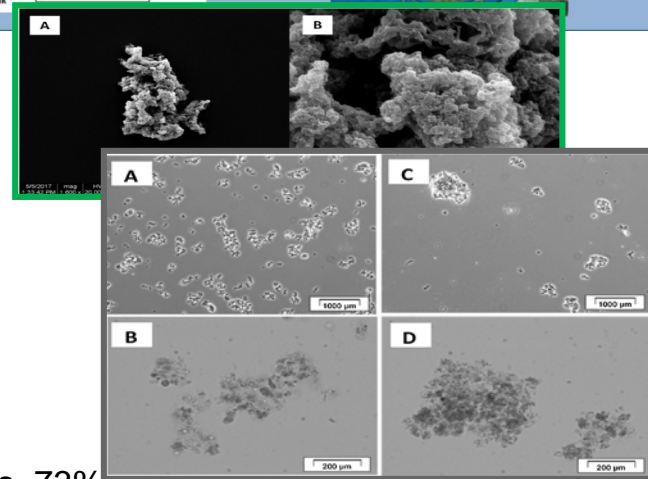
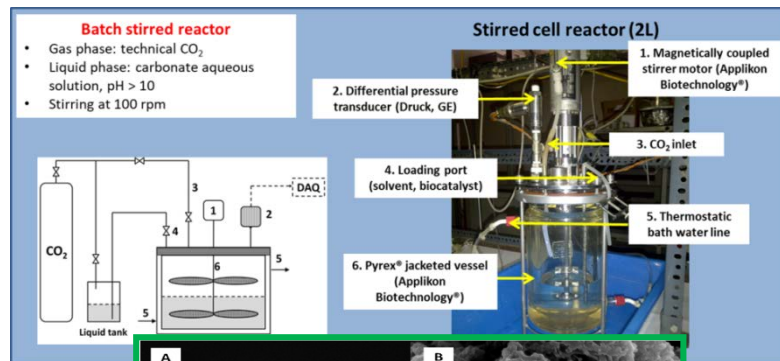



# Project Area: Low emission energy technologies

## Clean combustion: CO2 capture and storage

### Objective:

The study of the integration of Calcium looping process with concentrated solar power for CO2 capture and thermochemical storage to increase power flexibility

### Approach:

- Nighttime Operations
- - - Daytime Operations
- Full Day Operations

### Integration scheme

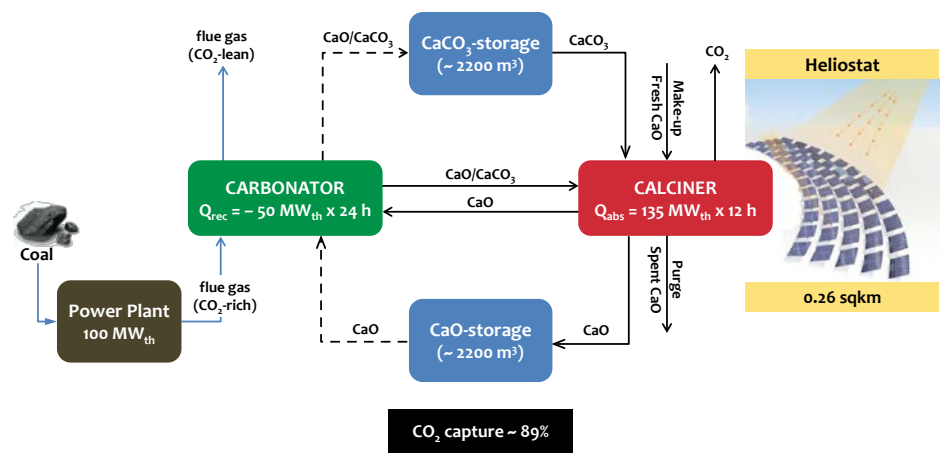

### Figures:

Interconnected fluidized bed configuration proposed

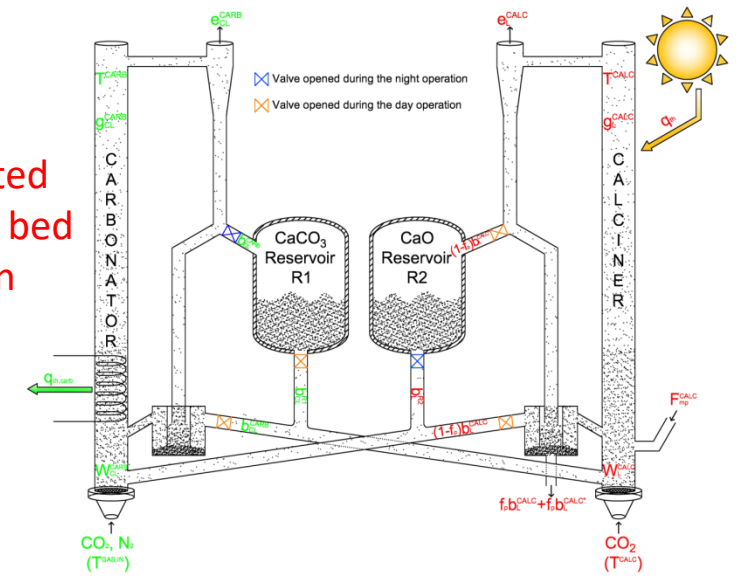

### Scientific Impact/Results:

CO<sub>2</sub> capture and carbonation conversion degree over iterated cycles



### Objective

To develop catalysts and catalytic processes for a large range of applications:

- Partial oxidation (production of syngas from methane or biogas) on sulfur-tolerant catalysts;
- Total oxidation (hybrid or high pressure catalytic combustion for gas turbine);
- Chemical looping combustion or reforming and solar water splitting with highly performing carriers;
- Gas upgrade (reforming of tar from biomass pyrolysis, purification of hydrogen stream for fuel-cell; purification of biogas from H<sub>2</sub>S);
- Catalytic conversion of ethanol to butanol as fuel additive;
- Abatement of NO<sub>x</sub> (low temperature SCR) and soot from diesel engines;
- CO<sub>2</sub> valorisation through methanation and methanol synthesis.

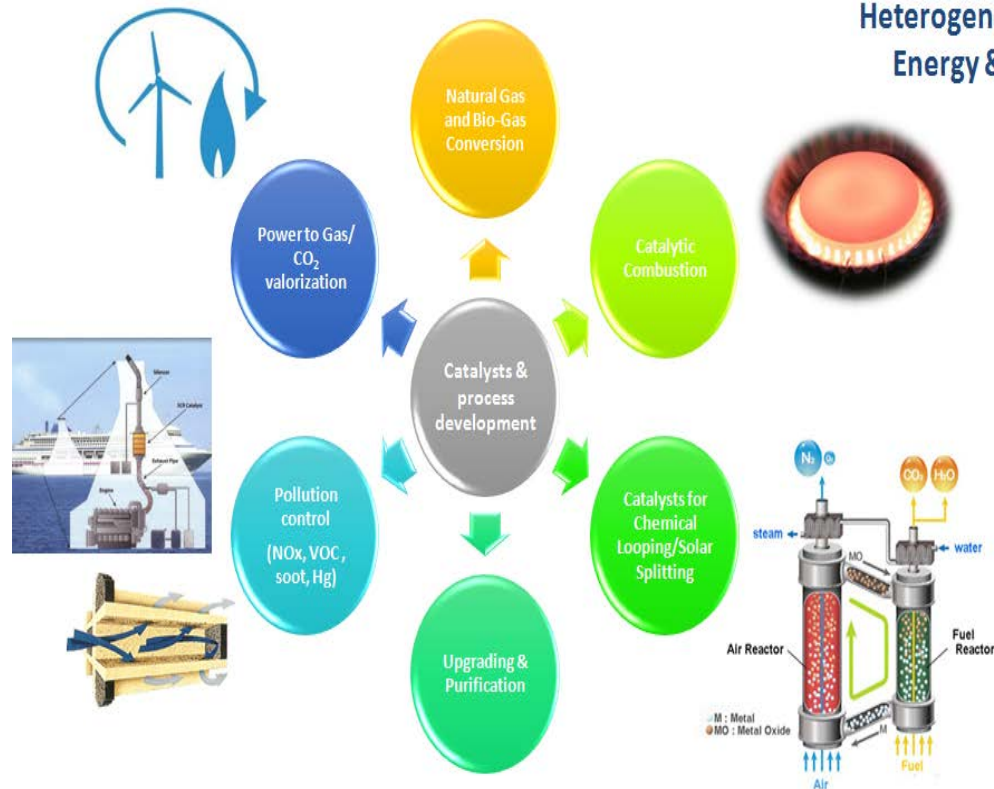



# Biofuels

- **Production:**
  - ❖ II and III gen liquid biofuels
  - ❖ Biogas
  - ❖ Syngas
- **Utilization:**
  - ❖ Efficient and low emission utilization of biofuels
  - ❖ Furnaces, engines and micro gas turbine
  - ❖ LHV biogas in commercial engines
  - ❖ Energy storage

**Objective:** Upgrading of thermo-chemical processes applied to waste and residual biomass to produce energy, H2 rich syngas, bio-oil

**Feedstocks:** biomass, wastes



**Thermo-catalytic conversion**  
- Gasification  
- Pyrolysis

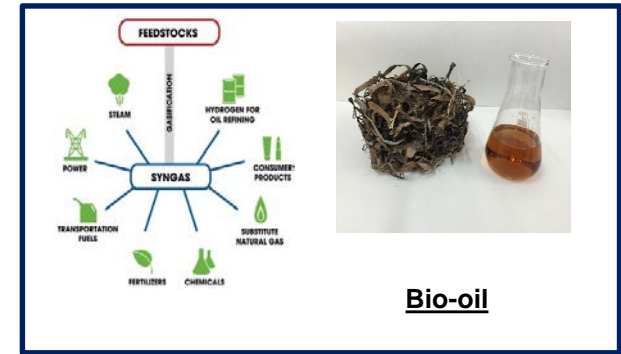

**Technologies:**

- Fluidized beds
- Entraained flow reactor
- Fixed beds
- Rotary kilns
- Plug flow reactors

**Facilities**

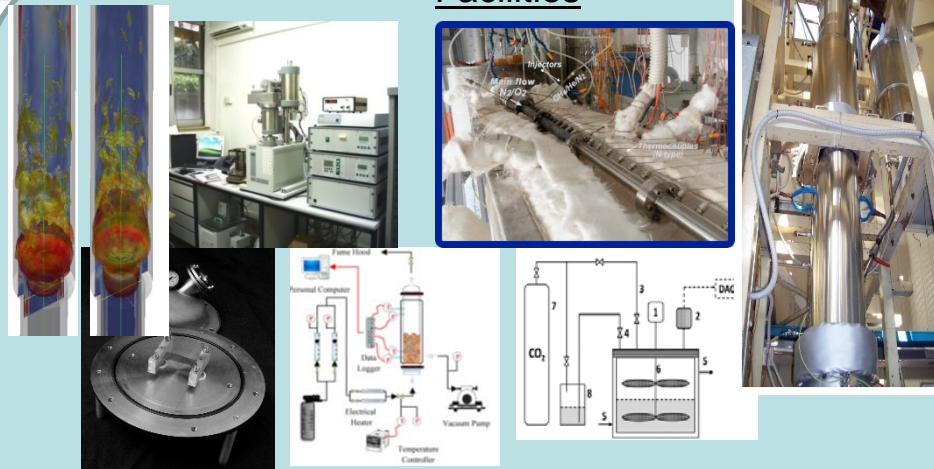

**Approach:**

- ✓ Analysis and characteriz. of feedstock and products
- ✓ Chemistry and kinetics
- ✓ Experiments from lab scale to pilot scale
- ✓ CFD modelling
- ✓ Preparation, characteriz. and testing of solid supported catalysts

**Steps of development of innovative materials/catalysts**



**Objective:**

**High quality gen II and III biofuels upgrading and characterization by means experimental characterization and numerical modeling**

**Approach:**

Numerical and experimental dedicated tools:

- Chemical analysis
- Reactions kinetics
- High pressure combustion cell
- Drop tube furnace
- Spray lab

**Scientific Impact/Results:**

- Automatic reduction of detailed mechanisms
- New algorithms to accurately reproduce the behavior of bio and alternative fuels
- Bio fuels from waste and biomass of low commercial value
- Fundamental combustion properties of II and III gen bio fuels
- High quality bio fuels (e.g., aeronautical applications)
- Optimization of bio-fuels production processes

Some images from test of crude pyrolysis oil droplet (European project: R2H - Renewable residential heating with fast pyrolysis bio - oil)

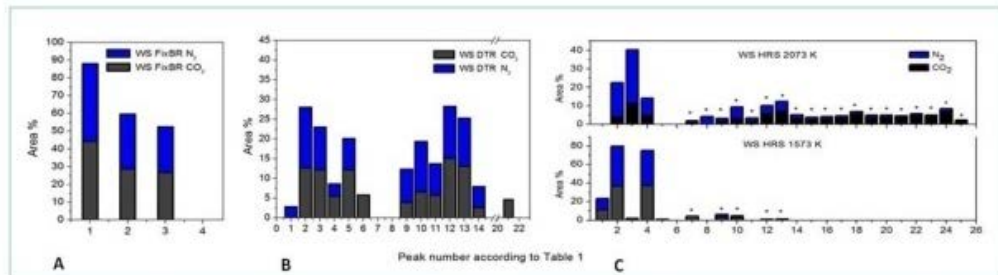
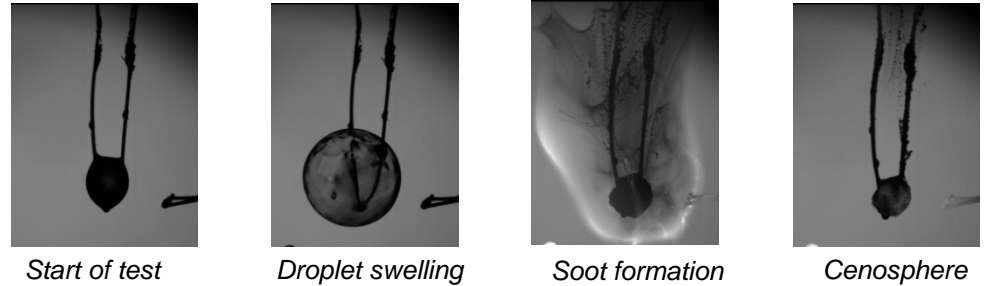

Tar Analysis

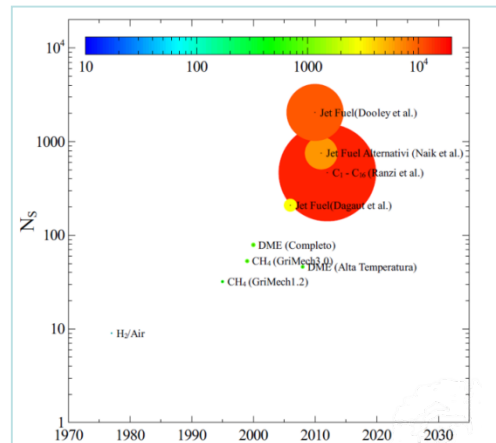

Increasing size of detailed mechanisms

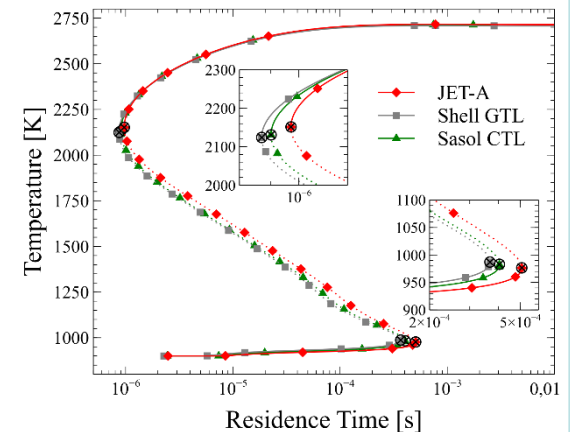

Parametric continuation of three different Jet fuels with detailed mechanisms



# Project Area: Low emission energy technologies

## Bio and alternative fuels: biogas/syngas upgrading and characterization



View of the Reformer connected with SOFC (SOFCOM EU Project)

**Design, realization and tests of compact reformers for the conversion of the biogas into a H<sub>2</sub> and CO rich syngas**

**Approach:** SR reforming /oxy-steam reforming, finalized to hydrogen or syngas production and/or integration with Fuel Cell systems for mobile and stationary applications in the range of 2kW.

**Target:** developing a compact unit, integrable with different downstream processes; high efficiency processing of different biogas feedstocks; use of low-cost Ni-based catalysts.

**Characterization of the burning properties of biogas and syngas, in precision-controlled conditions, typical of heat engines & burners.**

**Approach:** high-pressure, optically accessible cell, high time and space resolution diagnostics, precision-metered gas mixture composition.

**Target:** suggesting guidelines (design specifications and operating strategies) for the development of high-efficiency, ultra low-emission energy conversion systems

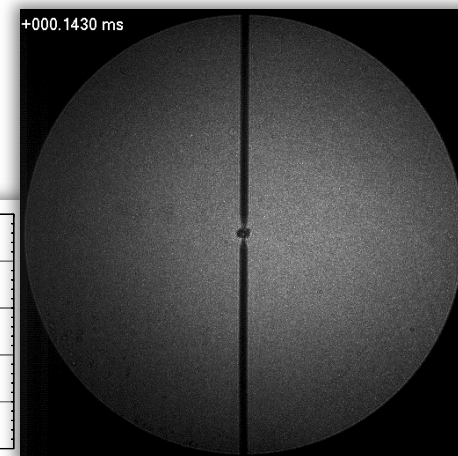
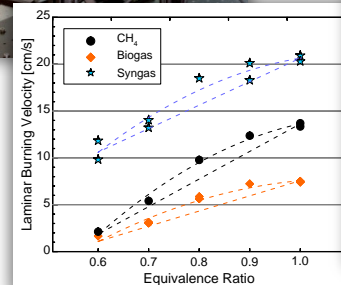
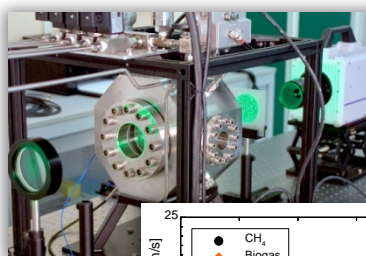

syngas flame at P<sub>0</sub>=10bar





# Project Area: Low emission energy technologies

## Bio and alternative fuels: end-user applications

### Identification of hydrogen concentration effects on syngas combustion in s.i. engines

**Approach:** combination of in-cylinder pressure measurements, exhaust gas emissions data and flame visualization in optically-accessible syngas-fueled SI engine.

**Target:** identifying the effect of syngas composition (specifically H<sub>2</sub>) on engine performance.

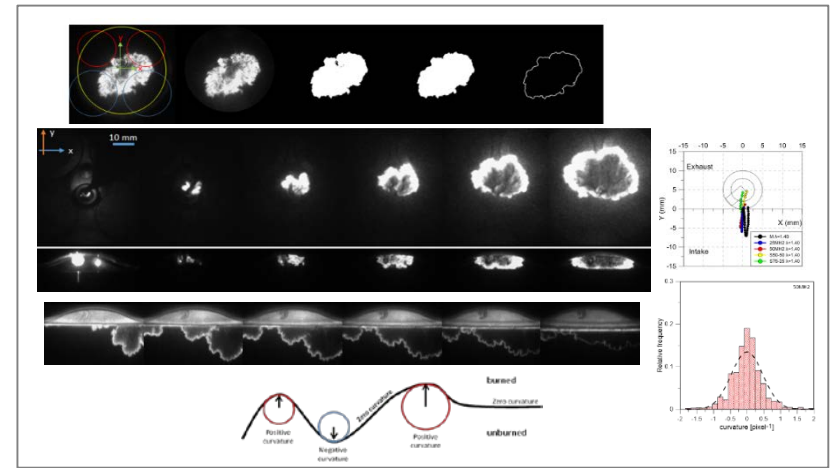
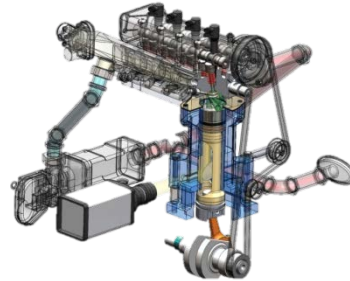

### Heavy duty s.i. engine powered with renewable gas fuels

**Approach:** bench testing of multi-cylinder s.i. turbocharged engine; performance analysis as a function of the blend composition and the ignition parameters.

**Target:** Optimization of engine control parameters to maximize performance as a function of fuel composition



### Utilization of bio and alternative LHV fuels in micro gas turbines

**Approach:** combination of numerical modelling and experimental analysis of a commercial 100kW MGT, customized to run under different operating conditions and with different fuels; purposely-built fuel supply system, providing gas mixture with variable amount of CH<sub>4</sub>, H<sub>2</sub>, CO<sub>2</sub> and CO.

**Target:** Extending the domain of operation and maximizing the efficiency of MGT running on alternative fuels.

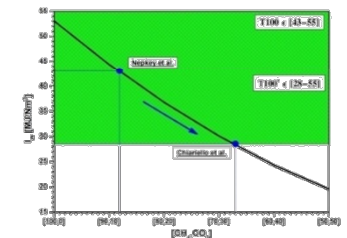

## **Flexibility and sustainability**

- **Energy storage and carriers**
- **Fuel cells**
  
- **Power grids**
- **Smart Micro-grids**



# Project Area: Low emission energy technologies

**Flexibility and sustainability:** Energy storage and carriers



Consiglio Nazionale delle Ricerche  
Engineering, ICT and Technologies for  
Energy and Transportation Department

## Objective:

- Development of innovative and highly performing materials and components for electrochemical storage devices (vanadium redox flow, sodium-ions, iron-air, sodium-nickel chloride batteries and supercapacitors) from battery cell level up to kW battery.
- Improving electrochemical performance in terms of current and power density, round-trip efficiency and cycling.

**The goal is a total costs reduction of the specific technology to allow the up-scaling favouring the market introduction**

## Approach:

- Low cost synthesis methods suitable for scale-up materials:

- Electrospinning technique
- Sol-gel
- Hydrothermal

- Low cost materials and components

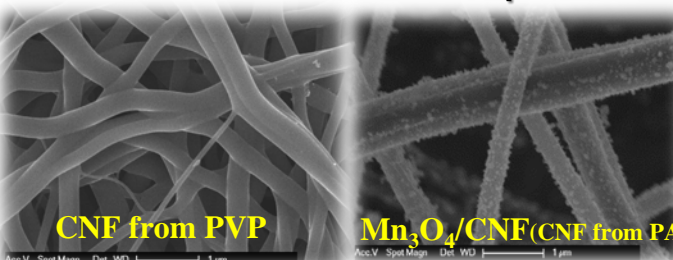

Electrospinning device



**Vanadium Redox Flow Battery**

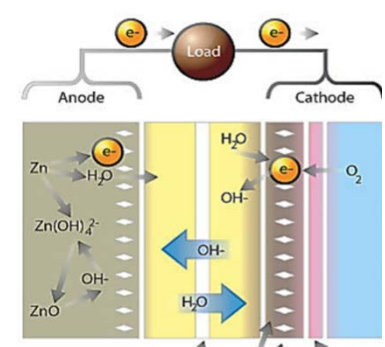
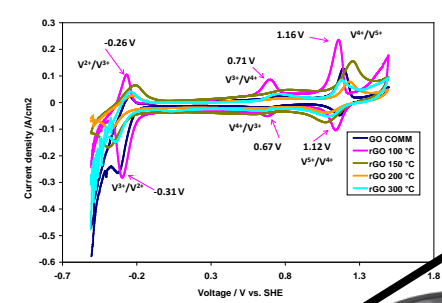

**Iron-air Battery process**

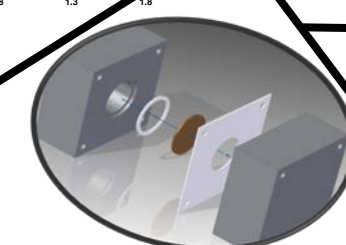
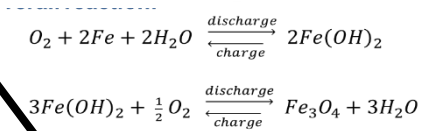

**Na-NiCl<sub>2</sub> innovative planar battery**



**20F - 3V**

**Supercap proof-of-concept**

## Scientific Impact/Results:

- Optimization of materials, components and design with respect to the state of art for current storage technologies
- Proof-of-concept of new electrochemical storage technology



# Project Area: Low emission energy technologies

## Flexibility and sustainability: Emission control



Consiglio Nazionale delle Ricerche  
Engineering, ICT and Technologies for  
Energy and Transportation Department

### Objective:

•Change in fuel composition or energy mix influence the design of the conversion system but also pollutants. It is urgent to improve knowledge on Formation mechanisms of new pollutants, and develop new diagnostics and abatement methodology.

### Approach:

Research activities are focused on:

1. Formation mechanisms of pollutants;
2. Advanced diagnostics for regulated / unregulated pollutants;
3. Reduction of pollutants from fossil and alternative fuels.

Specific activities include in-situ, on-line and off line advanced diagnostics of pollutants and ultrafine particles; diagnostic of flame instabilities; NO<sub>x</sub>, SO<sub>x</sub> and particulate reduction; SCR; Combined particulate and NO<sub>x</sub> reduction; NO<sub>x</sub> storage-decomposition for automotive application; PM reduction through water vapor condensation; Hg capture from flue gases; purification of CO<sub>2</sub> streams; tar and VOC abatement.

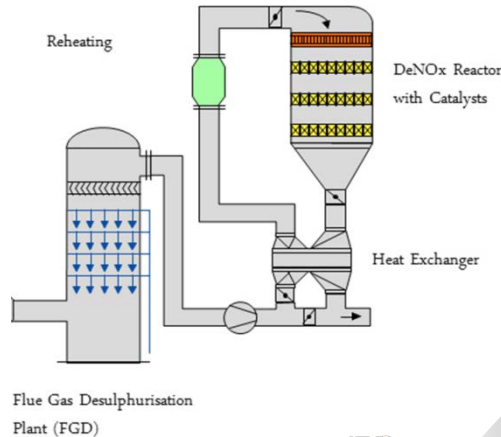

### Figures:

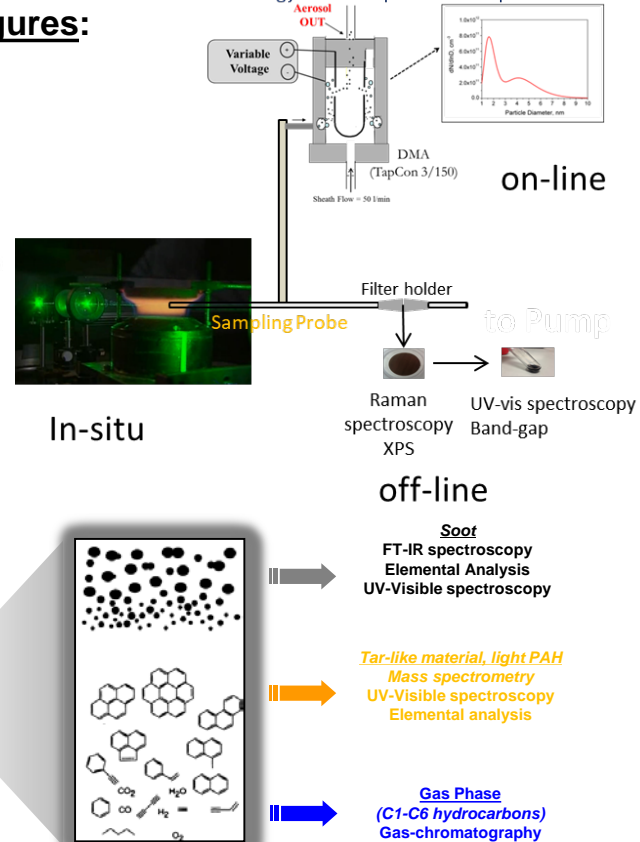

### Scientific Impact/Results:

- Physicochemical characterization of combustion generated carbon nanoparticles
- Characterization of main combustion products and intermediates
- Intensification of catalytic processes and development of novel materials





# Project Area: Low emission energy technologies

**Flexibility and sustainability:** Energy storage and carriers



Consiglio Nazionale delle Ricerche  
Engineering, ICT and Technologies for  
Energy and Transportation Department

## Objective:

- Development of innovative and highly performing materials and components for electrochemical storage devices (vanadium redox flow, sodium-ions, iron-air, sodium-nickel chloride batteries and supercapacitors) from battery cell level up to kW battery.
- Improving electrochemical performance in terms of current and power density, round-trip efficiency and cycling.

**The goal is a total costs reduction of the specific technology to allow the up-scaling favouring the market introduction**

## Approach:

- Low cost synthesis methods suitable for scale-up materials:

- Electrospinning technique
- Sol-gel
- Hydrothermal

- Low cost materials and components

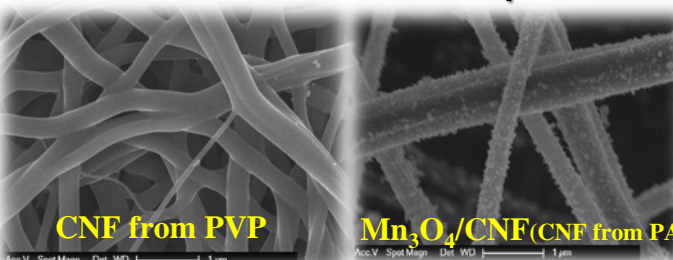

CNF from PVP

Mn<sub>3</sub>O<sub>4</sub>/CNF (CNF from PAN)

Electrospinning device

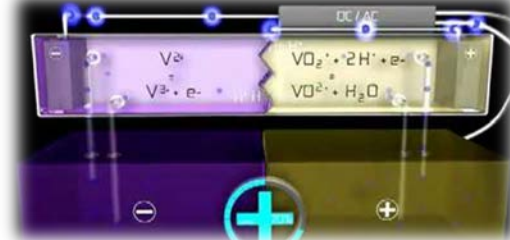

**Vanadium Redox Flow Battery**

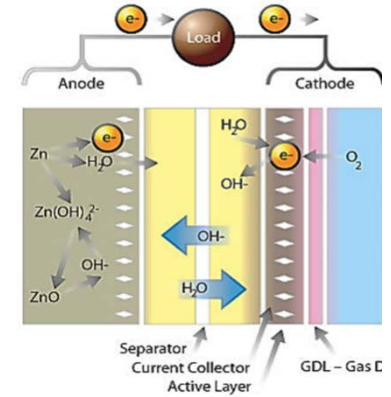
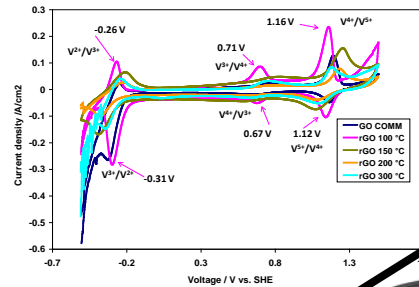

**Iron-air Battery process**

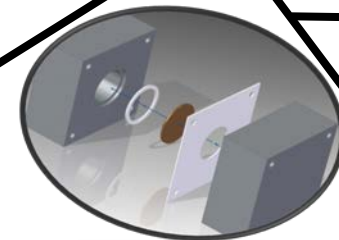
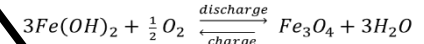
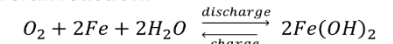

**Na-NiCl<sub>2</sub> innovative planar battery**



**20F - 3V**

**Supercap proof-of-concept**

## Scientific Impact/Results:

- Optimization of materials, components and design with respect to the state of art for current storage technologies
- Proof-of-concept of new electrochemical storage technology



# Project Area: Low emission energy technologies

**Flexibility and sustainability:** Energy storage and carriers



Consiglio Nazionale delle Ricerche  
Engineering, ICT and Technologies for  
Energy and Transportation Department

Energy storage of renewable energy is achieved producing H<sub>2</sub> for fuel cells by water electrolysis, photo-electrolysis, CO<sub>2</sub>-H<sub>2</sub>O co-electrolysis (to store electrical energy in chemicals such as methanol)

## Objective:

- Development of innovative and highly performing materials and components
- Improving the efficiency of the devices.



**1 kW PEM electrolyser system**

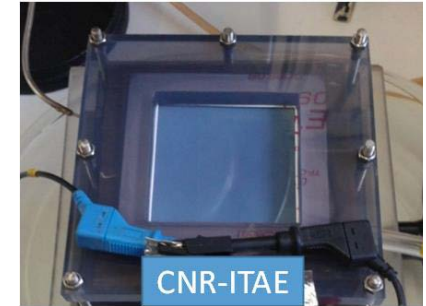

**Photo-electrolysis cell**

## CO<sub>2</sub>-H<sub>2</sub>O co-electrolysis materials and components

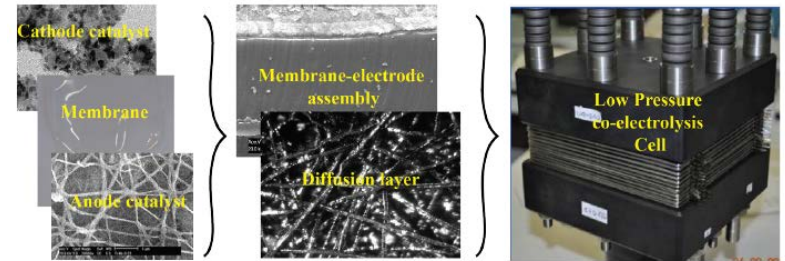

## Scientific Impact/Results:

- Optimization of materials and components
- Development of prototypes to validate the technology and the developed materials.
- Technology transfer and training

System design, system optimization, prototyping and validation in a field test at Emden (Germany)

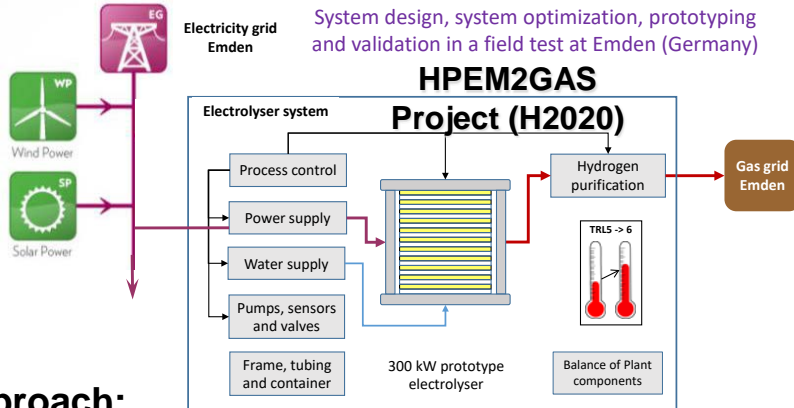

## Approach:

- **Synthesis methods for catalysts suitable for scaling-up**
- **Cost-effective materials and components**

- High Performance PEM Electrolyzer for Cost-effective Grid Balancing Applications (HPEM2GAS): G.A. n° 700008
- Next Generation PEM Electrolyzer under New Extremes (Neptune): G.A. n° 779540
- CRM-free Low Temperature Electrochemical Reduction of CO<sub>2</sub> to Methanol (LOTTER.CO2M): G.A. n° 761093
- Innovative Photoelectrochemical Cells for Solar Hydrogen Production (FotoH2): G.A. n° 760930



# Project Area: Low emission energy technologies

## Flexibility and sustainability: Fuel cells

**Objective:** The EU targets are the reduction of greenhouse gas (GHG) emissions by 40% by 2030 and by 80-95% by 2050 compared with 1990. Polymeric Electrolyte Membrane Fuel Cells (PEMFC) are environmental friendly. Although substantial progress has been achieved in the development of membrane-electrode assemblies (MEAs) for fuel cells, their high cost hinders the commercial breakthrough of PEMFC. Therefore it is urgently to improve MEA performance and durability to reduce cost and enable marketability of FC.

**Approach:** The development of new materials and improved membrane electrode assemblies is required to enable cost, performance and lifetime targets to be attained. It is necessary to develop and modify materials, such as polymeric membranes, ionomer dispersions, catalysts (e.g. Pt alloys and new supports with higher stability), and integrate them into high performing MEAs with superior durability. At the same time, it is necessary to improve the design of the stack. The problem related to the sealing concepts and stack design, such as the edge protection of the membrane and the sealing concept for the cooling media, have to be depth investigated to enhance the lifetime of the system.

### Figures:

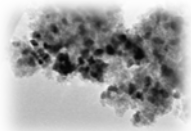

Catalysts based on Pt



Polymer functionalisation



Membranes

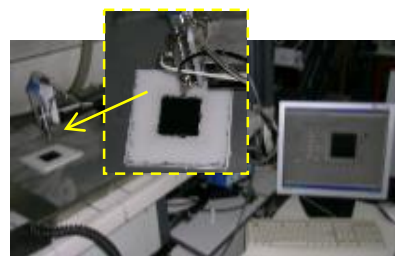

Automatic spray technique

Onto carbonaceous support

on Teflon and decal onto membrane

Onto membrane

MEA

3.5kW - M T PEM  
2 x 1.5 kW modules



1 kW H<sub>2</sub>/O<sub>2</sub>  
for Space application

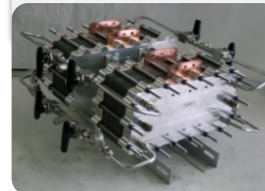

5 kW H<sub>2</sub>/air  
for Marine application



**Scientific Impact/Results:** The development of components such as catalysts, polymeric membranes, electrodes and MEAs, and their scale up from the lab scale to bigger size, has permitted the realisation of prototypes in a wide range of electric power. In particular a 3.5kW stack operating at 120°C for automotive, a 1kW stack operating in H<sub>2</sub>/O<sub>2</sub> for space application and a 5kW stack operating in H<sub>2</sub>/air for marine APU applications were developed.





# Project Area: Low emission energy technologies

## Flexibility and sustainability: Fuel cells

### Objective:

- Solid Oxide Fuel Cells (SOFCs) are based on *ceramic materials* and operate at high temperatures between 800-1000°C.
- The challenges in this sector are regarding the *reduction of the operation temperature* and the direct utilization of hydrocarbons.
- This will allow to decrease degradation and make the device cost-effective by system simplification (reduced fuel processing) and use of cheap ferritic steel interconnectors.

### Approach:

- The approach is to develop ceramic electrolytes for intermediate temperature operation based on ceria and gallates, use a multifunctional electrocatalytic layer at the anode to favour internal fuel processing and tailor the composition of the perovskite cathodes to speed-up the oxygen reduction process

### Figures:

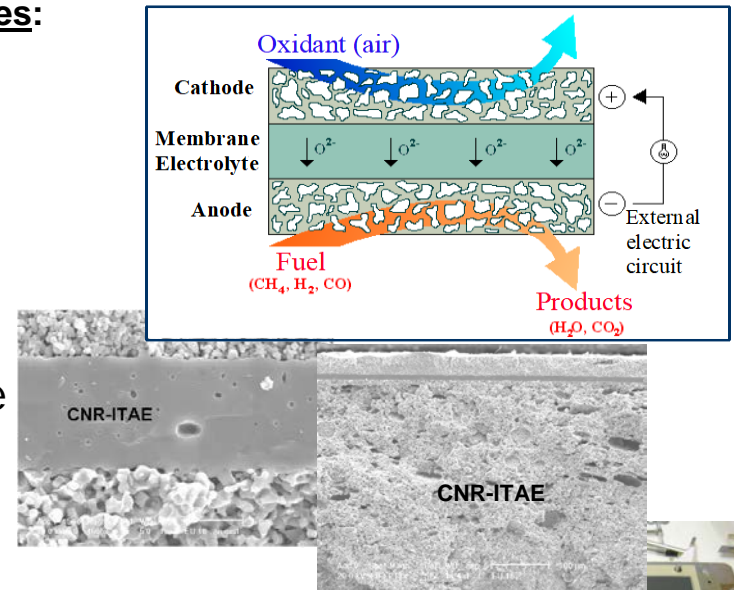

### Scientific Impact/Results:

- The new materials and cell architectures have been validated for the direct oxidation of hydrocarbons such as methane, ethanol, bio-gas, propane, reformed diesel etc. in systems up to 2 kW power

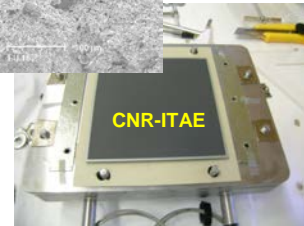





# Project Area: Low emission energy technologies

**Flexibility and sustainability:** Power grids

## Objective:

Design and experimental prototyping of several typologies and topologies of electronic power converters with high dynamic performance and high efficiency for interfacing the smart micro-grid with the main power network, renewables sources based generators and storage systems (batteries, supercapacitors).

## Approach:

Wide band gap (WBG) power devices technologies will be adopted, (SiC and GaN), permitting much higher voltages, frequencies and temperatures than conventional semiconductor materials.

The following typologies of power converters will be focused:

- DC-AC voltage source inverter (VSI), both in traditional 2-level and in multilevel configurations (particularly NPC = Neutral Point Clamped), including the related pulsewidth modulation techniques (PWM);
- AC-AC based on the combination of DC-AC converters in back-to-back configuration.
- DC-DC converters: buck, boost, bi-directional type. In particular boost converters with innovative structures characterized by high efficiency and low cost (low number of power devices) for the connection of fuel cell (FCS), micro-wind, marine and photovoltaic systems will be devised.

Innovative PWM and control techniques will be implemented experimentally on embedded platforms (DSP, FPGA, micro-controllers).

## Figures:



3-level NPC  
Voltage Source Inverter  
(20 kW)



DC-DC bidirectional  
Converter (2.6 kW)

## Scientific Impact/Results:

- Development of innovative power converters and related PWM and control techniques
- Technology transfer to SMEs and Industries
- Training of technicians and scientist in the field power converter design and control.



# Project Area: Low emission energy technologies

## Flexibility and sustainability of energy and power:

### Smart Micro-grids

#### Objective:

- Definition of new architectures for the electric energy distribution in smart micro-grids: DC distribution systems and hybrid AC/DC, with one or more voltage levels and their adoption in residential/commercial buildings as well as in smart vehicles, including ships.
- Definition of methodologies for the optimal and coordinated management, in smart micro-grids, of the following actors:
  - Distributed generators from renewable sources;
  - Stationary generation units (Fuel-cells);
  - Storage systems.
  - Loads.

#### Approach:

Development of data reconstruction and forecasting techniques of electric/meteo-climatic data as a part of the intelligent management of electric power grids:

- 1) electric energy production from renewable sources;
- 2) load demand.

Definition of EMS algorithms pursuing one or several specific goals:

- 1) maximum efficiency;
- 2) minimum losses;
- 3) minimum operating cost;
- 4) maximum self-sufficiency in islanded operation;
- 5) minimum uncertainty of the grid exchanged power profile.

Implementation of the forecasting and management algorithms on embedded platforms (FPGA, micro-controllers).

#### Figures:

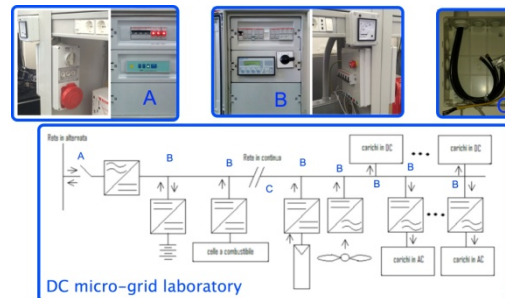

Flussi di potenza governati da EMS

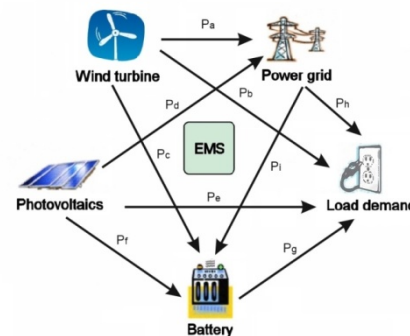

#### Scientific Impact/Results:

- Development of innovative distribution architectures of smart micro-grids and related energy management systems, of potential interest from the power network manager and companies.
- Technology transfer to SMEs and Industries
- Training of technicians and scientist in the field smart micro-grids and their management